



ABUTMENTS

MADE IN GERMANY

Unsere Serien im Überblick

Heliocos Serie	Kompatibler Hersteller	Kompatibles Implantatsystem	Verfügbare Plattformen
AT-EV	Dentsply®	Astra Tech® OsseoSpeed™ EV	3,0 3,6 4,2 4,8 5,4
AT-TX	Dentsply®	Astra Tech® OsseoSpeed™ TX	3,0 3,5 4,0 4,5 5,0
CL-CO	Altatec®	Conelog®	3,3 3,8 4,3 5,0
CL-SR	Altatec®	Camlog®	3,3 3,8 4,3 5,0 6,0
DS-AY	Dentsply®	Ankylos® C/X	A B C D
FX	Dentsply®	Xive® S	3,4 3,8 4,5 5,5
ME-IX	Medentis Medical®	ICX	3,75 4,1 4,8
NB-AV	Nobel Biocare AB®	Conical Connection	3,0 NP RP WP
NB-RS	Nobel Biocare AB®	Tri Lobe [Tri-Channel]	NP RP WP
SM-BL	Straumann®	Bone Level	NC RC
SM-TL	Straumann®	Tissue Level	NNC RN WN
ZMB	BioHorizons®	Tapered Plus, Mount-Free Tapered, Tapered Tissue Level	3,5 4,5 5,7
ZMB	MIS®	SEVEN® (internal Hex)	Standard (3,75 4,2) Weit (5 6)
ZMB	Zimmer Dental®	Tapered Screw-Vent®	3,5 4,5 5,7

Inhaltsverzeichnis

Unsere Serien im Überblick.....	2
Über Heliocos.....	8
Sicherheit und Qualität.....	8
Made in Germany.....	8
Versand.....	8
Bestellinformationen.....	8
Die Heliocos Titanbasis.....	8
Das Heli-Loc® Abutment.....	10
Das Heliocos Multi-Unit Abutment.....	11
SM-BL Serie – kompatibel zu Straumann® - Bone Level.....	12
Abutmentschrauben.....	13
Laborschrauben.....	13
Laboranaloge.....	13
Gerade Abutments.....	13
Gewinkelte Abutments.....	14
Titanbasen kurz, CAD/CAM.....	14
Titanbasen lang, CAD/CAM.....	14
Titanbasen nicht indexiert, CAD/CAM.....	14
Scanbodys.....	15
Pre-Mill Abutments.....	15
Multi-Unit Abutments NC.....	15
Multi-Unit Abutments RC.....	15
Multi-Unit Zubehör.....	16
Abformpfosten kurz (offene Abformung).....	16
Abformpfosten lang (offene Abformung).....	16
Heli-Loc (Deckprothesen Abutment).....	17
Gingivaformer.....	17
SM-TL Serie - kompatibel zu Straumann® - Tissue Level.....	18
Abutmentschrauben.....	19
Laborschrauben.....	19
Laboranaloge.....	19
Gerade Abutments.....	20
Gewinkelte Abutments.....	20
Titanbasen kurz, CAD/CAM.....	20
Titanbasen lang, CAD/CAM.....	21
Titanbasen nicht indexiert, CAD/CAM.....	21
Scanbodys.....	21
Pre-Mill Abutments.....	21
Multi-Unit Abutments.....	22
Multi-Unit Zubehör.....	22
Abformpfosten kurz (offene Abformung).....	22
Abformpfosten lang (offene Abformung).....	22

Inhaltsverzeichnis

Gingivaformer	23
CL-SR Serie - kompatibel zu Altatec® (Camlog®) - Screw-Line / Root-Line2® / Progressiv-Line	24
Abutmentschrauben	25
Laborschrauben.....	25
Laboranaloge	25
Gerade Abutments	26
Gewinkelte Abutments.....	26
Massivabutments	27
Titanbasen kurz, CAD/CAM.....	27
Titanbasen lang, CAD/CAM.....	27
Titanbasen nicht indexiert, CAD/CAM	27
Scanbodys	28
Pre-Mill Abutments.....	28
Multi-Unit Abutments 3,8	28
Multi-Unit Abutments 4,3 / 5,0	28
Multi-Unit Zubehör	29
Abformpfosten kurz (offene Abformung)	29
Abformpfosten lang (offene Abformung)	29
Heli-Loc (Deckprothesen Abutment)	30
Gingivaformer	30
CL-CO Serie - kompatibel zu Altatec® (Camlog®) - Conelog®.....	31
Abutmentschrauben	32
Laborschrauben.....	32
Laboranaloge	32
Gerade Abutments	33
Gewinkelte Abutments.....	33
Titanbasen kurz, CAD/CAM.....	33
Titanbasen lang, CAD/CAM.....	34
Titanbasen nicht indexiert, CAD/CAM	34
Scanbodys	34
Pre-Mill Abutments.....	34
Multi-Unit Abutments.....	35
Multi-Unit Zubehör	35
Abformpfosten kurz (offene Abformung)	35
Abformpfosten lang (offene Abformung)	35
Heli-Loc (Deckprothesen Abutment)	36
Gingivaformer	36
AT-TX Serie - kompatibel zu Dentsply® - Astra Tech® OsseoSpeed™ TX	37
Abutmentschrauben	38
Laborschrauben.....	38
Laboranaloge	38
Gerade Abutments	39
Gewinkelte Abutments.....	39
Titanbasen kurz, CAD/CAM.....	40

Inhaltsverzeichnis

Titanbasen lang, CAD/CAM.....	40
Titanbasen nicht indexiert, CAD/CAM	40
Scanbodys	41
Pre-Mill Abutments.....	41
Multi-Unit Abutments D3,5 / 4,0	41
Multi-Unit Abutments D4,5 / 5,0	41
Multi-Unit Zubehör	42
Abformpfosten kurz (offene Abformung).....	42
Abformpfosten lang (offene Abformung)	42
Heli-Loc (Deckprothesen Abutment)	43
Gingivaformer	43
AT-EV Serie - kompatibel zu Dentsply® – Astra Tech® OsseoSpeed™ EV.....	45
Abutmentschrauben	46
Laborschrauben.....	46
Laboranaloge	46
Gerade Abutments	47
Gewinkelte Abutments.....	47
Titanbasen kurz, CAD/CAM.....	48
Titanbasen lang, CAD/CAM.....	48
Titanbasen nicht indexiert, CAD/CAM	48
Scanbodys	49
Pre-Mill Abutments.....	49
Multi-Unit Abutments D3,6.....	49
Multi-Unit Abutments D4,2.....	49
Multi-Unit Abutments D4,8.....	49
Multi-Unit Zubehör	50
Abformpfosten kurz (offene Abformung).....	50
Abformpfosten lang (offene Abformung)	50
Heli-Loc (Deckprothesen Abutment)	51
Gingivaformer	52
FX Serie – kompatibel zu Dentsply® – Xive® S	53
Abutmentschrauben	54
Laborschrauben.....	54
Laboranaloge	54
Gerade Abutments	55
Gewinkelte Abutments / 15 Grad.....	55
Gewinkelte Abutments / 25 Grad.....	55
Titanbasen kurz, CAD/CAM.....	56
Titanbasen lang, CAD/CAM.....	56
Titanbasen nicht indexiert, CAD/CAM	56
Scanbodys	56
Pre-Mill Abutments.....	57
Multi-Unit Abutments D3,4.....	57
Multi-Unit Abutments D3,8.....	57

Inhaltsverzeichnis

Multi-Unit Abutments D4,5.....	57
Multi-Unit Zubehör.....	58
Abformpfosten kurz (offene Abformung).....	58
Abformpfosten lang (offene Abformung).....	58
Heli-Loc (Deckprothesen Abutment).....	59
Gingivaformer.....	60
DS-AY Serie - kompatibel zu Dentsply® – Ankylos® C/X.....	61
Abutmentschrauben.....	62
Laborschrauben.....	62
Laboranalogue.....	62
Gerade Abutments.....	62
Gewinkelte Abutments (X).....	63
Nicht indexierte Abutments (C).....	63
Titanbasen, CAD/CAM.....	63
Scanbodys.....	64
Pre-Mill Abutments.....	64
Multi-Unit Abutments.....	64
Multi-Unit Zubehör.....	64
Abformpfosten (offene Abformung).....	65
Heli-Loc (Deckprothesen Abutment).....	65
Gingivaformer.....	65
ZMB Serie - kompatibel zu Zimmer Dental® - TSRV / MIS® – Seven® / Biohorizons® - Internal Hex.....	66
Abutmentschrauben.....	67
Laborschrauben.....	67
Laboranalogue.....	67
Gerade Abutments.....	68
Gewinkelte Abutments / 16 Grad.....	68
Gewinkelte Abutments / 25 Grad.....	68
Titanbasen kurz, CAD/CAM.....	69
Titanbasen lang, CAD/CAM.....	69
Titanbasen nicht indexiert, CAD/CAM.....	69
Scanbodys.....	70
Pre-Mill Abutments.....	70
Multi-Unit Abutments D3,5.....	70
Multi-Unit Abutments D4,5.....	70
Multi-Unit Zubehör.....	70
Abformpfosten kurz (offene Abformung).....	71
Abformpfosten lang (offene Abformung).....	71
Heli-Loc (Deckprothesen Abutment).....	71
Gingivaformer.....	72
NB-AV Serie - kompatibel zu Nobel Biocare® - NobelActive® /NobelParallel Conical Connection / NobelReplace® Conical Connection.....	73
Abutmentschrauben.....	74
Laborschrauben.....	74

Inhaltsverzeichnis

Laboranaloge	74
Gerade Abutments	75
Gewinkelte Abutments.....	75
Titanbasen kurz, CAD/CAM.....	76
Titanbasen lang, CAD/CAM.....	76
Titanbasen nicht indexiert, CAD/CAM	76
Scanbodys	77
Pre-Mill Abutments.....	77
Multi-Unit Abutments NP.....	77
Multi-Unit Abutments RP	77
Multi-Unit Zubehör	78
Abformpfosten kurz (offene Abformung).....	78
Abformpfosten lang (offene Abformung)	78
Heli-Loc (Deckprothesen Abutment)	79
Gingivaformer.....	80
Zubehör für Heli-Loc Abutments	81
Retentionseinsätze ohne Pin für Heli-Loc Abutments	81
Retentionseinsätze mit Pin für Heli-Loc Abutments	81
Laborsets für Heli-Loc Abutments	81
Kompatibel zu Nobel Biocare® - Tri Lobe [Tri-Channel] - Nobel Replace® Tapered Groovy, NobelSpeedy Replace / NobelReplace® Straight / Replace Select Straight / Replace Select Tapered®	82
Kompatibel zu Bego® - Semados® (S / RI / RS / RSX / SC / SCX)	82
Kompatibel zu Medentis Medical® - ICX®	83
Heli-Loc	83
Löseinstrument für DS-AY Serie	84
Instrumente	85
Drehmomentratsche und Universalratsche	85
Adapter und Handrad	85
Torx® T6 - kompatibel zu SM-BL / SM-TL	85
Hex 1,26 - kompatibel zu AT-EV / AT-TX / CL-CO / CL-SR / ZMB	85
Hex 1,22 - kompatibel zu FX	86
Hex 1,01 - kompatibel zu DS-AY	86
Hex 1,40 - kompatibel zu ME-IX	86
UniGrip - kompatibel zu NB-AV / NB-RS	86
Eindrehinstrument Multi-Unit (Multi-Unit Serie) und Heli-Loc.....	86
Installationsanleitung der Heliocos Bibliotheken	87
Hinweise für Exocad®.....	87
Hinweise für 3shape®.....	88
Etiketten	89
Drehmomente	90
Die rechtliche Situation bei kompatiblen Produkten.....	91
Die Gewährleistung bzw. die Sachmängelhaftung.....	91
Die Garantie	91

Über Heliocos

Sicherheit und Qualität

Langjährige Erfahrung in der Dentalbranche und hervorragendes technologisches Verständnis führen zu perfekten Produkten. Höchste Präzision an der Schnittstelle zum Implantat und durchdachte Schraubverbindungen führen zu sehr guten Ergebnissen in der Ermüdungsprüfung nach DIN EN ISO 14801. Wir erfüllen alle behördlichen und normativen Anforderungen. Unser **Qualitätsmanagementsystem** ist nach **DIN EN ISO 13485** zertifiziert. Ebenfalls verfügen wir über eine **EU-Qualitätsmanagementbescheinigung** nach **Verordnung (EU) 2017/745 (MDR)**.

Made in Germany

Unsere Produkte werden in Deutschland produziert, das ist uns wichtig. Mit einer hervorragenden Qualität und einem attraktiven Preis-Leistungs-Verhältnis überzeugen wir unsere Kunden.

Versand

Bestelleingang

Montag – Freitag 8:00 – 16:00 Uhr

Zustellung am nächsten Arbeitstag

Tagesende (nur Deutschland) € 8,50 netto

bis 12 Uhr (nur Deutschland) € 13,50 netto

Bei Bestellwert über 250 € (netto) werden 8,50 € Versandkosten erlassen.

- Internationale Versandkosten finden Sie auf unserem Webshop.

Bestellinformationen

Webshop: <https://shop.heliocos.de/>

E-Mail: vertrieb@heliocos.de

Fon: +49 721 75 40 36 31 / Fax: +49 721 75 40 36 34

Alle Preise zzgl. gesetzlicher Mehrwertsteuer.

Unser Webshop

shop.heliocos.de

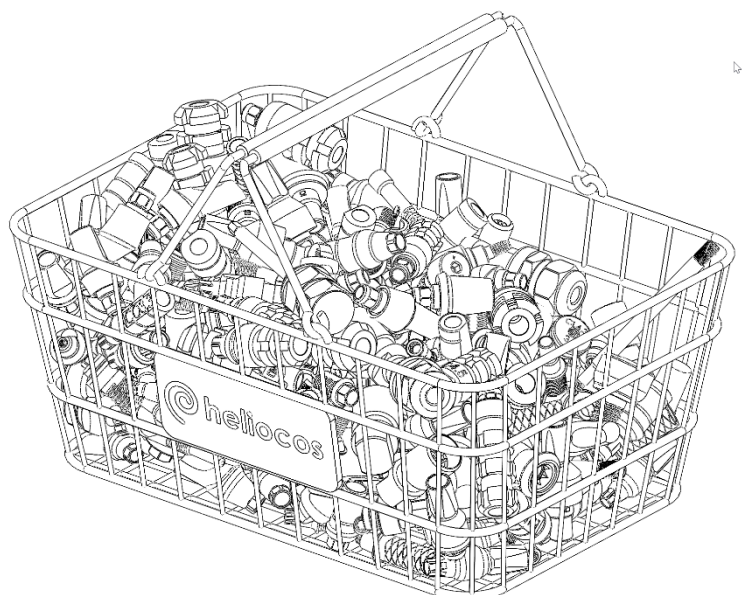

Die Heliocos Titanbasis

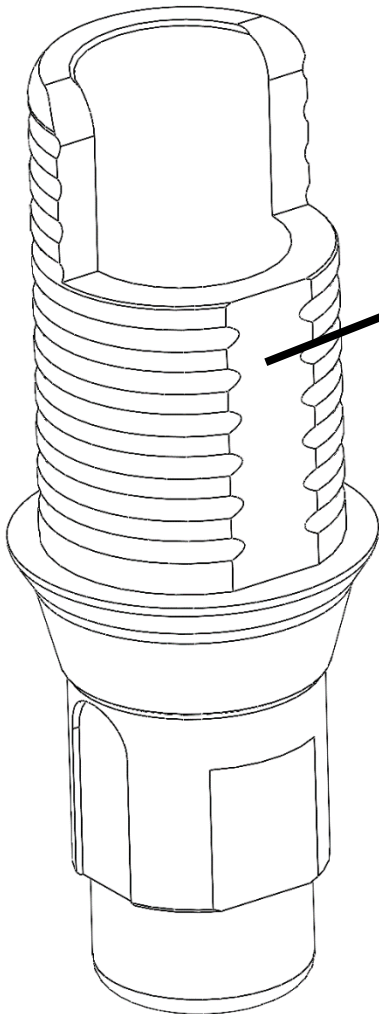

Bewährtes Flat-Lock Design.

Keine Nocke zur Rotationssicherung der Krone nötig. Somit ist die Gefahr des Kronenbruchs an der dünnsten Stelle der Krone stark reduziert.

- Flat-Lock Design für Rotationssicherung der Krone
- Abgewinkelter Schraubenkanal möglich
- Zwei Kaminhöhen verfügbar
- Inkl. Abutmentschraube
- Steg-Brücken Varianten verfügbar
- Verwendbar mit Scanbody | Bibliothek von Heliocos
- Scanbodys von Heliocos (aus Titan Grade 4 / intraoral nutzbar)
- Vorhandene Eindrehinstrumente können verwendet werden

Das Heli-Loc® Abutment

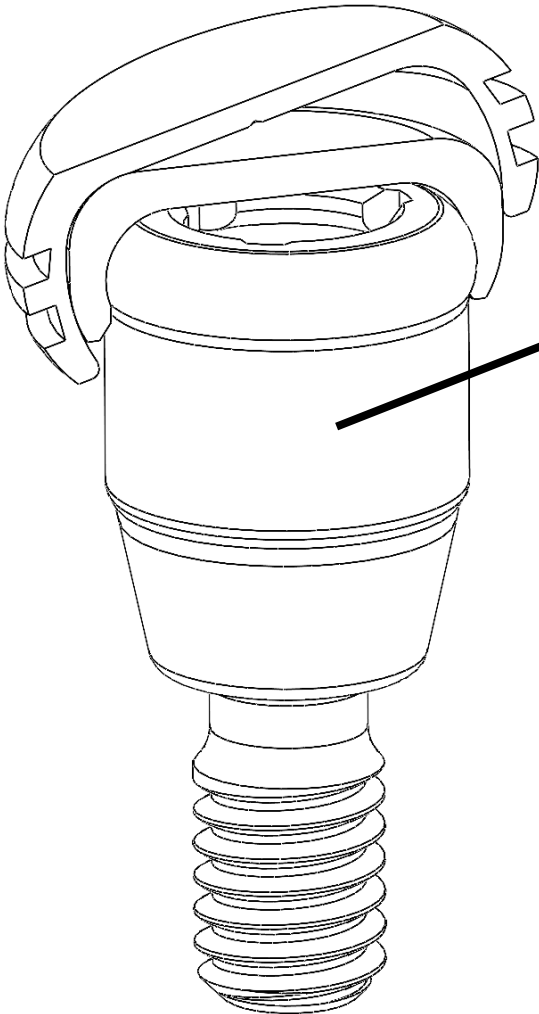

TiN Beschichtung.

Die sehr harte Titannitrid (TiN) Beschichtung wirkt als Verschleißschutz des Abutments.

- Bewährtes Design
- Mehrere Gingivahöhen verfügbar
- Umfangreiches Zubehör verfügbar
- Vorhandene Eindrehinstrumente können verwendet werden

Das Heliocos Multi-Unit Abutment

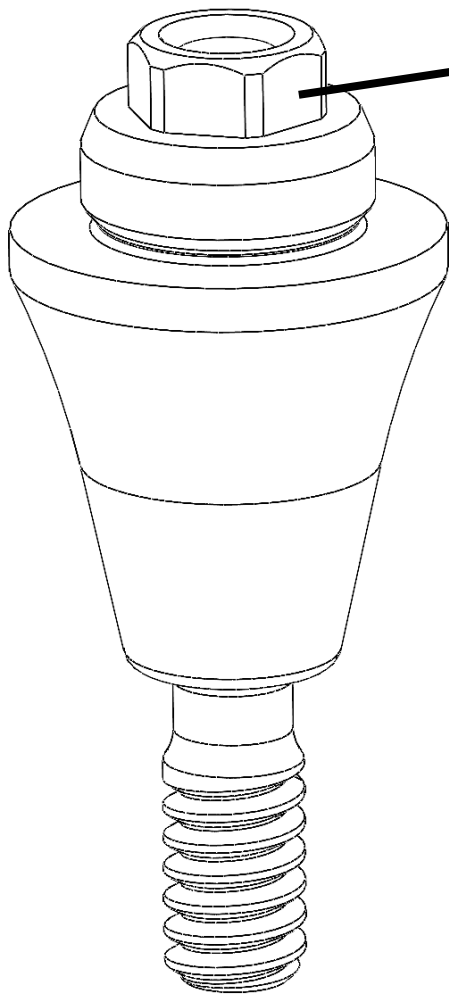

Bewährtes Design.

Alle Heliocos Multi-Unit Abutments haben das gleiche Kamindesign. Damit können implantatherstellerübergreifende Versorgungen realisiert werden.

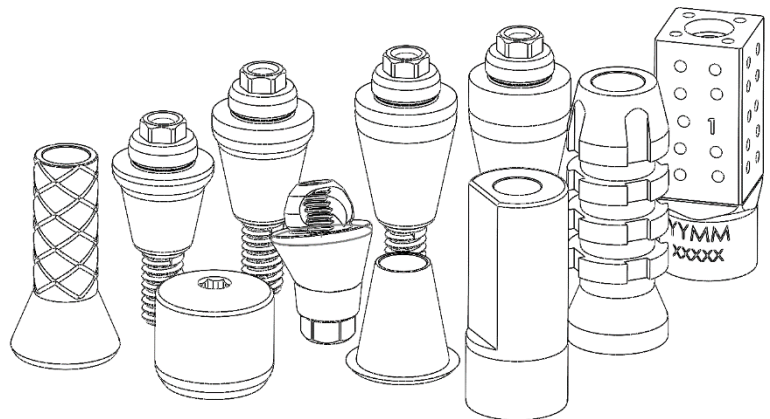

- Bewährtes Design für alle Heliocos Serien
- Umfangreiches Zubehör verfügbar
- Verwendbar mit Scanbody | Bibliothek von Heliocos
- Scanbodys von Heliocos (aus Titan Grade 4 / intraoral nutzbar)
- Vorhandene Eindrehinstrumente können verwendet werden

SM-BL Serie – kompatibel zu **Straumann®** - Bone Level

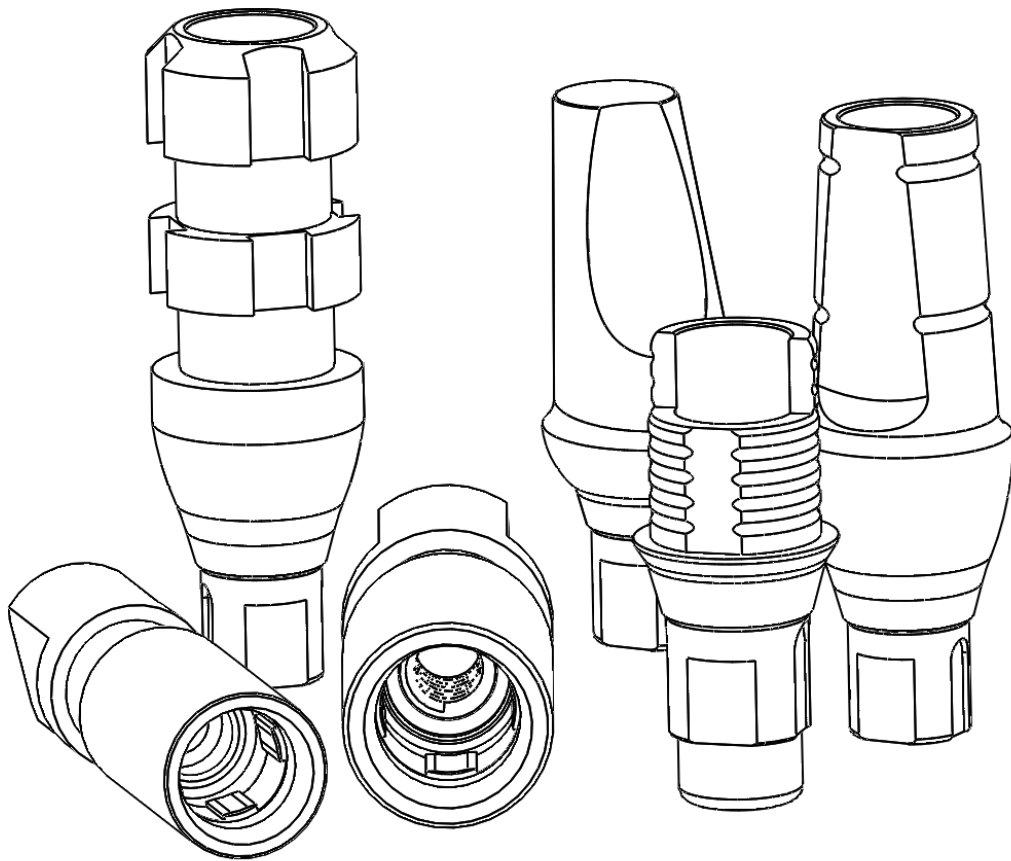

SM-BL Serie – kompatibel zu Straumann® - Bone Level

Abutmentschrauben

Titan Grade 5, unsteril, Anschluss: Torx® T6



 [Per Klick zum Webshop](#)

Plattform	NC / RC	Multi-Unit
Größe	M 1,6	M 1,4
REF	21.338.00.085	21.183.21.035
Preis [EUR]	10,-	10,-

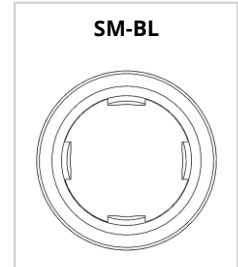

Laborschrauben

Titan Grade 5, unsteril, Anschluss: Torx® T6, farbcodiert gelb/ Drehmoment: Handfest



Plattform	NC / RC	Multi-Unit
Größe	M 1,6	M 1,4
REF	24.009.00.085	24.108.21.035
Preis [EUR]	6,-	6,-
Ab 5 Stk.	4,-	4,-
Ab 10 Stk.	3,50	3,50

Laboranaloge

Titan Grade 5, unsteril, farbcodiert, 3D Druck geeignet

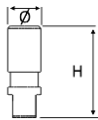

Plattform	NC	RC
H [mm]	12	12
Ø [mm]	3,3	4,1
Farbcodierung	gelb	lila
REF	24.007.33.010	24.008.00.010
Preis [EUR]	12,-	12,-
Ab 10 Stk.	9,-	9,-
Ab 30 Stk.	8,-	8,-

Passende Instrumente ab S. 85

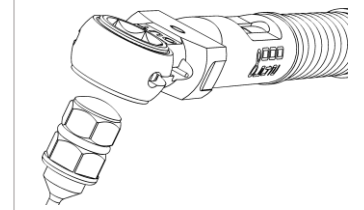

Gerade Abutments

Titan Grade 5, unsteril, inkl. Schraube / Drehmoment: 35 Ncm

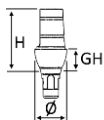

[KLICK ZUM WEBSHOP](#)

Plattform	NC	NC	RC	RC
GH [mm]	1,5	3	1,5	3
H [mm]	8	8	9,6	9,6
Ø [mm]	4,2	4,2	5	5
REF	21.116.33.000	21.118.33.000	21.117.00.000	21.119.00.000
Preis [EUR]	60,-	60,-	60,-	60,-

Gewinkelte Abutments

Titan Grade 5, unsteril, inkl. Schraube / Drehmoment: 35 Ncm

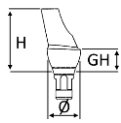

[KLICK ZUM WEBSHOP](#)

	Plattform	NC	NC	RC	RC
	GH [mm]	1,5	3	1,5	3
	H [mm]	7,7	7,7	8,1	8,1
	Ø [mm]	4,2	4,2	5	5
REF	Typ 2 (18°)	21.126.33.000	21.134.33.000	21.127.00.000	21.135.00.000
	Preis [EUR]	75,-	75,-	75,-	75,-

Titanbasen kurz, CAD/CAM

Titan Grade 5, unsteril, inkl. Schraube / Drehmoment: 35 Ncm / kompatibel mit: Exocad® & 3shape®

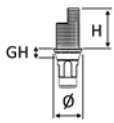

Passende Instrumente ab S. 85

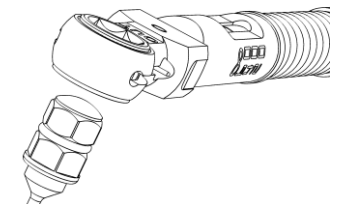

	Plattform	NC	RC
	GH [mm]	1	0,8
	H [mm]	4	4
	Ø [mm]	3,7	4
REF	Typ 1	21.150.33.000	21.151.00.000
	Preis [EUR]	45,-	45,-

Titanbasen lang, CAD/CAM

Titan Grade 5, unsteril, inkl. Schraube / Drehmoment: 35 Ncm / kompatibel mit: Exocad® & 3shape®

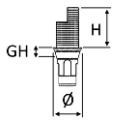

[Per Klick zum Webshop](#)

	Plattform	NC	RC
	GH [mm]	1	0,8
	H [mm]	5,5	5,5
	Ø [mm]	3,7	4
REF	Typ 1	21.154.33.000	21.155.00.000
	Preis [EUR]	45,-	45,-

Titanbasen nicht indiziert, CAD/CAM

Titan Grade 5, unsteril, inkl. Schraube / Drehmoment: 35 Ncm / ohne Rotationsschutz / kompatibel mit: Exocad® & 3shape®

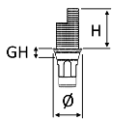

	Plattform	NC	RC
	GH [mm]	1	0,8
	H [mm]	3,5	3,5
	Ø [mm]	3,7	4,3
REF	Typ 1	21.159.33.000	21.160.00.000
	Preis [EUR]	40,-	40,-

Scanbodys

Titan Grade 4, unsteril, inkl. Schraube / Drehmoment: Handfest



Plattform	NC	RC
REF	21.336.33.147	21.337.00.147
Preis [EUR]	30,-	30,-

Scanbodys sind wieder aufbereitbar und für den intraoralen Einsatz geeignet.

Pre-Mill Abutments

Titan Grade 5, unsteril, inkl. Schraube / Drehmoment: 35 Ncm, kompatibel zum Medentika®-Halter



Plattform	NC	RC	RC
Ø [mm]	11,5	11,5	15,8
REF	25.029.11.000	25.037.11.000	25.039.15.000
Preis [EUR]	37,-	37,-	37,-

Multi-Unit Abutments NC

Titan Grade 5, unsteril / Drehmoment: 35 Ncm



[Per Klick zum Webshop](#)

Plattform	NC	NC	NC
GH [mm]	1,5	2,5	3,5
REF	21.164.33.087	21.165.33.097	21.166.33.107
Preis [EUR]	49,-	49,-	49,-

Multi-Unit Abutments RC

Titan Grade 5, unsteril / Drehmoment: 35 Ncm



Plattform	RC	RC	RC	RC
GH [mm]	1,5	2,5	3,5	4,5
REF	21.169.00.088	21.170.00.098	21.171.00.108	21.172.00.118
Preis [EUR]	49,-	49,-	49,-	49,-



Multi-Unit Zubehör

Titan Grade 5, unsteril, Anschluss: Torx® T6

[KLICK ZUM WEBSHOP](#)

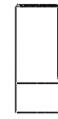

**Titanbasis
Multi-Unit,
CAD/CAM**

**Titankappe
Multi-Unit**

**Verschlusskappe
Multi-Unit**

**Scanbody
Multi-Unit**

**Abformpfosten
Multi-Unit
(offene
Abformung)**

**Laboranalog
Multi-Unit**

<i>Material</i>	Titan Grade 5	Titan Grade 5	Titan Grade 5	Titan Grade 4	Titan Grade 5	Titan Grade 5
<i>inkl. Schraube</i>	ja	ja	nein	ja	ja	nein
<i>Drehmoment</i>	15 Ncm	15 Ncm	Handfest	Handfest	Handfest	-
<i>REF</i>	21.187.42.000	21.185.30.000	21.182.45.037	21.321.00.000	23.032.45.000	24.048.45.100
<i>Preis [EUR]</i>	39,-	39,-	18,-	30,-	26,-	12,-

Abformpfosten kurz (offene Abformung)

Titan Grade 5, unsteril, inkl. Schraube, farbcodiert / Drehmoment: Handfest

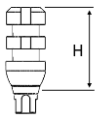

Plattform	NC	RC
<i>H [mm]</i>	10	10
<i>Farbcodierung</i>	gelb	lila
<i>REF</i>	23.023.33.000	23.024.00.000
<i>Preis [EUR]</i>	26,-	26,-

Passende Instrumente ab S. 85

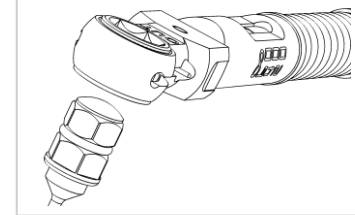

Abformpfosten lang (offene Abformung)

Titan Grade 5, unsteril, inkl. Schraube, farbcodiert / Drehmoment: Handfest

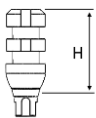

[Per Klick zum Webshop](#)

Plattform	NC	RC
<i>H [mm]</i>	15	15
<i>Farbcodierung</i>	gelb	lila
<i>REF</i>	23.028.33.000	23.029.00.000
<i>Preis [EUR]</i>	26,-	26,-

Heli-Loc (Deckprothesen Abutment)

Titan Grade 5 mit TiN-Beschichtung, unsteril, Drehmoment: 35 Ncm

[KLICK ZUM WEBSHOP](#)



Plattform	NC	NC	NC	NC
GH [mm]	1	2	3	4
REF	26.099.33.010	26.101.33.020	26.102.33.030	26.103.33.040
Preis [EUR]	59,-	59,-	59,-	59,-



Plattform	RC	RC	RC	RC
GH [mm]	1	2	3	4
REF	26.106.41.010	26.107.41.020	26.108.41.030	26.109.41.040
Preis [EUR]	59,-	59,-	59,-	59,-

Zubehör zu den Heli-Loc Abutments auf Seite 81

Gingivaformer

Titan Grade 5, unsteril, lasermarkiert / Drehmoment: Handfest

[KLICK ZUM WEBSHOP](#)

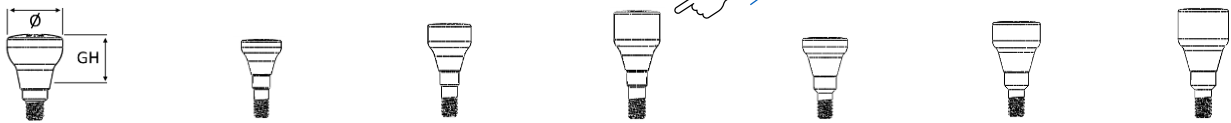

Plattform	NC	NC	NC	RC	RC	RC
GH [mm]	3	4	5	3	4	5
Ø [mm]	4,5	4,5	4,5	4,9	4,9	4,9
REF	22.569.33.030	22.570.33.040	22.571.33.050	22.572.41.030	22.573.41.040	22.574.41.050
Preis [EUR]	18,-	18,-	18,-	18,-	18,-	18,-

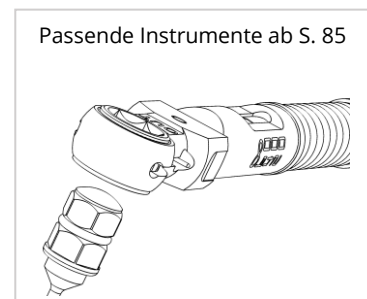
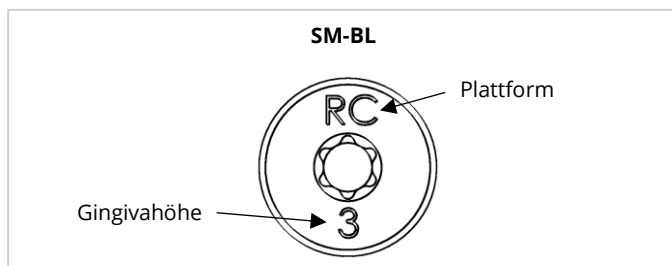

SM-TL Serie - kompatibel zu **Straumann®** - Tissue Level

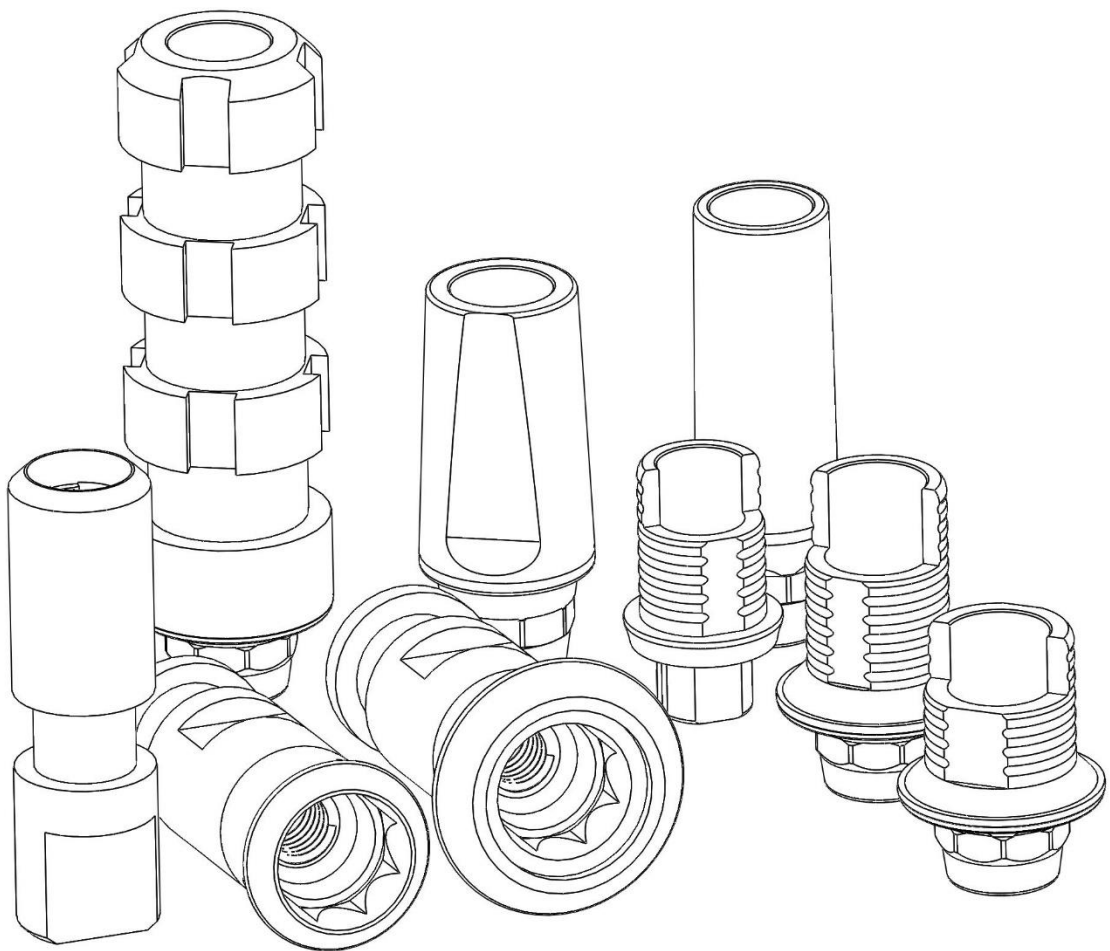

SM-TL Serie – kompatibel zu Straumann® - Tissue Level

Abutmentschrauben

Titan Grade 5, unsteril, Anschluss: Torx® T6



Plattform	NNC	RN / WN	Multi-Unit
Größe	M 1,6	M 2,0	M 1,4
REF	22.199.16.071	22.200.20.067	21.183.21.035
Preis [EUR]	10,-	10,-	10,-

Laborschrauben

Titan Grade 5, unsteril, Anschluss: Torx® T6, farbcodiert gelb/ Drehmoment: Handfest



[KLICK ZUM WEBSHOP](#)

Plattform	NNC	RN / WN	Multi-Unit
Größe	M 1,6	M 2,0	M 1,4
REF	24.066.16.071	24.067.20.065	24.108.21.035
Preis [EUR]	6,-	6,-	6,-
Ab 5 Stk.	4,-	4,-	4,-
Ab 10 Stk.	3,50	3,50	3,50

Laboranaloge

Titan Grade 5, unsteril, farbcodiert

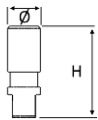

Plattform	NNC	RN	RN*	WN	WN*
H [mm]	12	12	12	12	9
Ø [mm]	3,5	4,8	4,8	6,5	6,5
Farbcodierung	keine	rot	rot	grün	grün
REF	24.063.35.010	24.064.48.010	24.103.48.120	24.065.65.010	24.104.65.100
Preis [EUR]	12,-	12,-	12,-	12,-	12,-
Ab 10 Stk.	9,-	9,-	9,-	9,-	9,-
Ab 30 Stk.	8,-	8,-	8,-	8,-	8,-

*) Für 3D gedruckte Modelle geeignet.

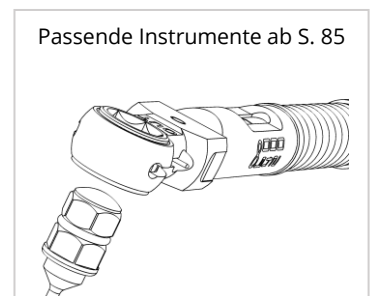
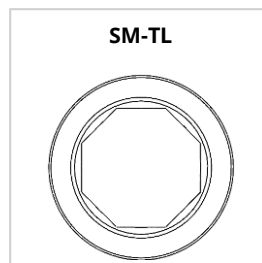

Gerade Abutments

Titan Grade 5, unsteril, inkl. Schraube / Drehmoment: 35 Ncm

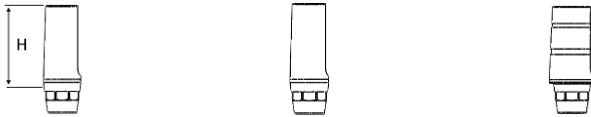

 [Per Klick zum Webshop](#)

	Plattform	RN	WN
<i>H [mm]</i>		8	8
<i>REF</i>		22.223.48.000	22.224.65.000
<i>Preis [EUR]</i>		60,-	60,-

Gewinkelte Abutments

Titan Grade 5, unsteril, inkl. Schraube / Drehmoment: 35 Ncm

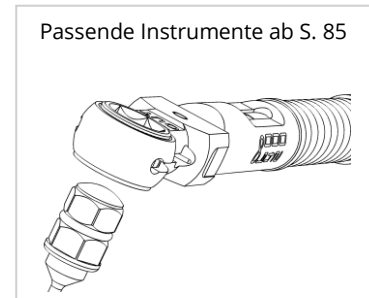

	Plattform	RN
<i>H [mm]</i>		7
<i>REF</i>	Typ 2 (15°)	22.235.48.000
<i>REF</i>	Typ 2 (25°)	22.247.48.000
<i>Preis [EUR]</i>		75,-



Titanbasen kurz, CAD/CAM

Titan Grade 5, unsteril, inkl. Schraube / Drehmoment: 35 Ncm / kompatibel mit: Exocad® & 3shape®



 [KLICK ZUM WEBSHOP](#)

	Plattform	NNC	RN	WN
<i>H [mm]</i>		4	4	4
<i>REF</i>	Typ 1	22.270.33.000	22.271.48.000	22.272.65.000
<i>Preis [EUR]</i>		45,-	45,-	45,-

Titanbasen lang, CAD/CAM

Titan Grade 5, unsteril, inkl. Schraube / Drehmoment: 35 Ncm / kompatibel mit: Exocad® & 3shape®

[KLICK ZUM WEBSHOP](#)



Plattform		NNC	RN	WN
	<i>H [mm]</i>	5,5	5,5	5,5
<i>REF</i>	Typ 1	22.276.33.000	22.277.48.000	22.278.65.000
	<i>Preis [EUR]</i>	45,-	45,-	45,-

Titanbasen nicht indexiert, CAD/CAM

Titan Grade 5, unsteril, inkl. Schraube / Drehmoment: 35 Ncm / ohne Rotationsschutz / kompatibel mit: Exocad® & 3shape®



Plattform		NNC	RN	WN
	<i>H [mm]</i>	4	4	4
<i>REF</i>	Typ 1	22.294.33.000	22.295.48.000	22.296.65.000
	<i>Preis [EUR]</i>	40,-	40,-	40,-

Scanbodys

Titan Grade 4, unsteril, inkl. Schraube / Drehmoment: Handfest

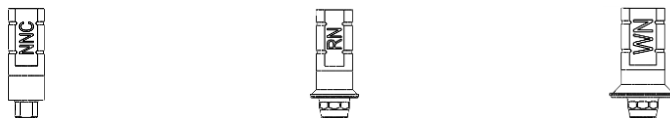

Plattform		NNC	RN	WN
<i>REF</i>		22.300.33.000	22.301.48.000	22.302.65.000
	<i>Preis [EUR]</i>	30,-	30,-	30,-

Scanbodys sind wieder aufbereitbar und für den intraoralen Einsatz geeignet.

Pre-Mill Abutments

Titan Grade 5, unsteril, inkl. Schraube / Drehmoment: 35 Ncm, kompatibel zum Medentika®-Halter



Plattform		RN	RN	WN
	<i>∅ [mm]</i>	11,5	15,8	15,8
<i>REF</i>		25.172.11.000	25.174.15.000	25.182.15.000
	<i>Preis [EUR]</i>	37,-	37,-	37,-

Multi-Unit Abutments

Titan Grade 5, unsteril / Drehmoment: 35 Ncm

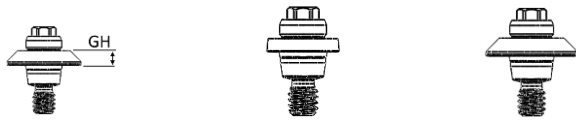

[Per Klick zum Webshop](#)

Plattform	RN	WN
REF	22.304.48.009	22.305.65.013
Preis [EUR]	49,-	49,-

Multi-Unit Zubehör

Titan Grade 5, unsteril, Anschluss: Torx® T6



	Titanbasis Multi-Unit, CAD/CAM	Titankappe Multi-Unit	Verschlusskappe Multi-Unit	Scanbody Multi-Unit	Abformpfosten Multi-Unit (offene Abformung)	Laboranalog Multi-Unit
Material	Titan Grade 5	Titan Grade 5	Titan Grade 5	Titan Grade 4	Titan Grade 5	Titan Grade 5
inkl. Schraube	ja	ja	nein	ja	ja	nein
Drehmoment	15 Ncm	15 Ncm	Handfest	Handfest	Handfest	-
REF	21.187.42.000	21.185.30.000	21.182.45.037	21.321.00.000	23.032.45.000	24.048.45.100
Preis [EUR]	39,-	39,-	18,-	30,-	26,-	12,-

Abformpfosten kurz (offene Abformung)

Titan Grade 5, unsteril, inkl. Schraube, farbcodiert / Drehmoment: Handfest

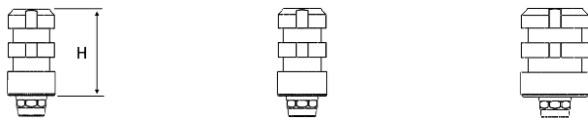

Plattform	RN	WN
H [mm]	9	9
Farbcodierung	rot	grün
REF	23.147.48.000	23.148.65.000
Preis [EUR]	26,-	26,-

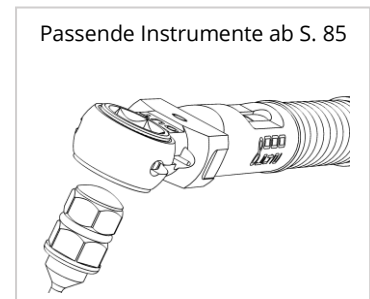

Abformpfosten lang (offene Abformung)

Titan Grade 5, unsteril, inkl. Schraube, farbcodiert / Drehmoment: Handfest

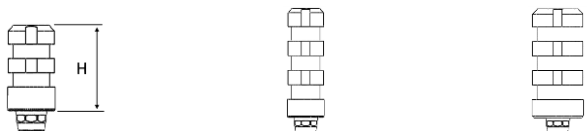

[Per Klick zum Webshop](#)

Plattform	RN	WN
H [mm]	15	15
Farbcodierung	rot	grün
REF	23.155.48.000	23.156.65.000
Preis [EUR]	26,-	26,-

Gingivaformer

Titan Grade 5, unsteril, inkl. Schraube, lasermarkiert / Drehmoment: Handfest

[KLICK ZUM WEBSHOP](#)

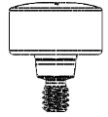
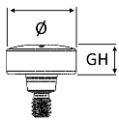

Plattform	RN	RN	RN	WN	WN	WN
GH [mm]	2	3	4	2	3	4
Ø [mm]	5,5	5,5	5,5	7,2	7,2	7,2
REF	22.578.48.020	22.579.48.030	22.580.48.040	22.581.65.020	22.582.65.030	22.583.65.040
Preis [EUR]	18,-	18,-	18,-	18,-	18,-	18,-

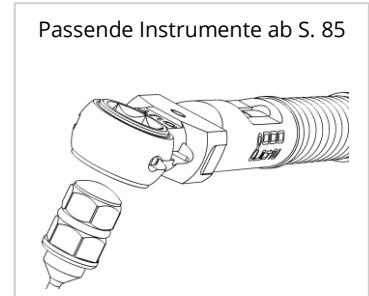
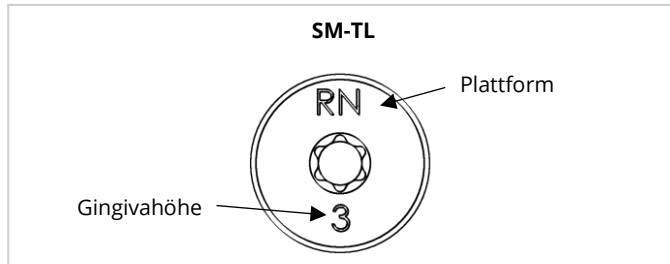

CL-SR Serie - kompatibel zu Altatec® (Camlog®) - Screw-Line / Root-Line2® / Progressiv-Line

CL-SR Serie - kompatibel zu **Altatec® (Camlog®) - Screw-Line / Root-Line2® / Progressiv-Line**

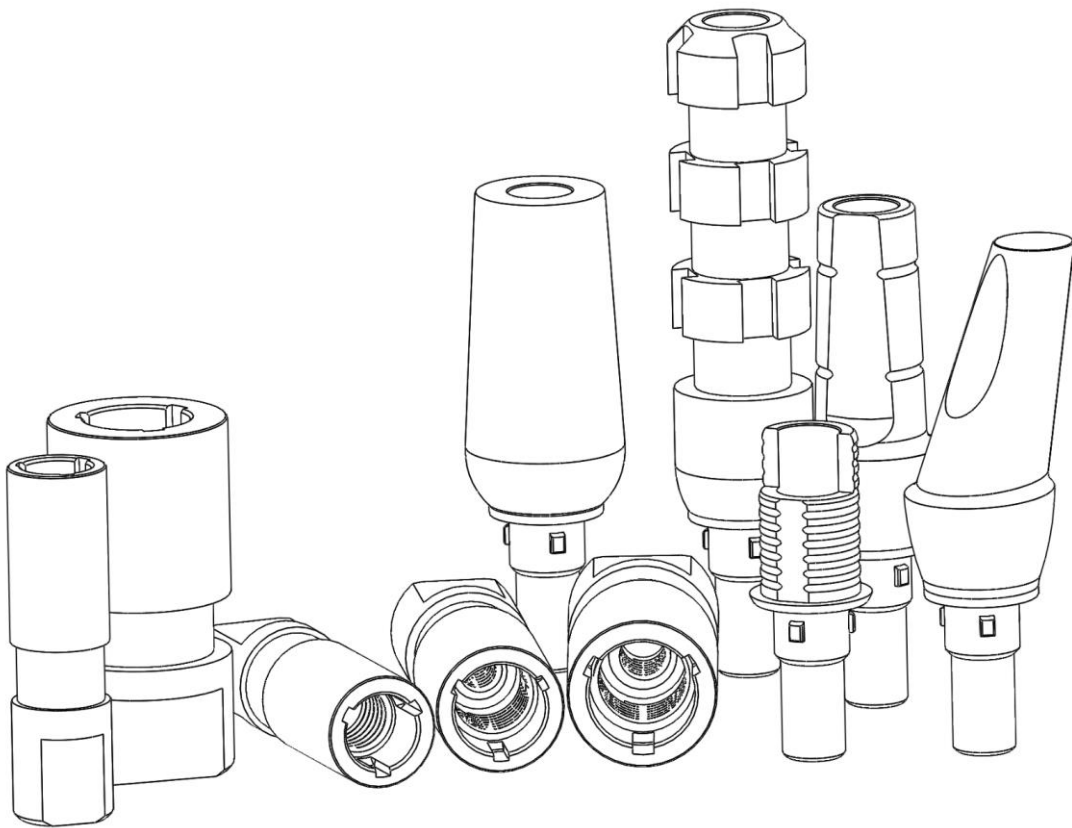

Abutmentschrauben

Titan Grade 5, unsteril, Anschluss: Hex 1,26



Plattform	3,3 / 3,8 / 4,3	5,0 / 6,0	Multi-Unit
Größe	M 1,6	M 2,0	M 1,4
REF	21.430.16.105	21.431.20.105	21.094.21.035
Preis [EUR]	10,-	10,-	10,-

Laborschrauben

Titan Grade 5, unsteril, Anschluss: Hex 1,26, farbcodiert gelb/ Drehmoment: Handfest



Plattform	3,3 / 3,8 / 4,3	5,0 / 6,0	Multi-Unit
Größe	M 1,6	M 2,0	M 1,4
REF	24.061.16.105	24.062.20.105	24.107.21.035
Preis [EUR]	6	6	6
ab 5 Stk.	4	4	4
ab 10 Stk.	3,5	3,5	3,5

Laboranaloge

Titan Grade 5, unsteril, farbcodiert, für 3D Druck geeignet

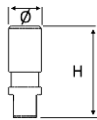

Plattform	3,3	3,8	4,3	5,0 / 6,0
H [mm]	12	12	12	12
Ø [mm]	3,3	3,8	4,3	5,0
Farbcodierung	keine	gelb	rot	blau
REF	24.056.33.010	24.057.38.010	24.058.43.010	24.059.50.010
Preis [EUR]	12,-	12,-	12,-	12,-
ab 10 Stk.	9,-	9,-	9,-	9,-
ab 30 Stk.	8,-	8,-	8,-	8,-

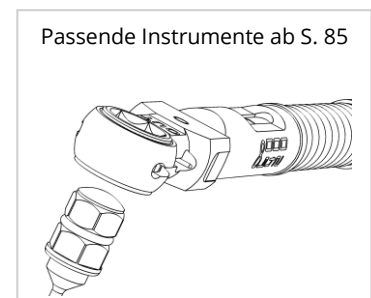
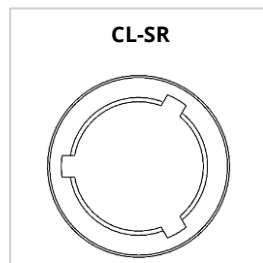

Gerade Abutments

Titan Grade 5, unsteril, inkl. Schraube / Drehmoment: 20 Ncm

[KLICK ZUM WEBSHOP](#)

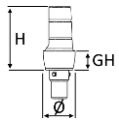

Plattform	3,8	3,8	4,3	4,3	5,0	5,0
GH [mm]	1,5	3,5	1,5	3,5	1,5	3,5
H [mm]	9	11,7	9	11,7	9	11,7
Ø [mm]	4,7	4,7	5,3	5,3	5,8	5,8
REF	21.458.38.000	21.459.38.000	21.460.43.000	21.461.43.000	21.462.50.000	21.463.50.000
Preis [EUR]	60,-	60,-	60,-	60,-	60,-	60,-

Gewinkelte Abutments

Titan Grade 5, unsteril, inkl. Schraube / Drehmoment: 20 Ncm

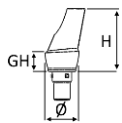

Plattform	3,8	3,8	4,3	4,3
GH [mm]	1,5	3,5	1,5	3,5
H [mm]	9	11,7	9	11,7
Ø [mm]	5	5	5,5	5,5
REF Typ A (17°)	21.474.38.000	21.475.38.000	21.476.43.000	21.477.43.000
Preis [EUR]	75,-	75,-	75,-	75,-

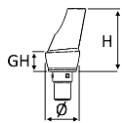

[Per Klick zum Webshop](#)

Plattform	5,0	5,0
GH [mm]	1,5	3,5
H [mm]	9	11,7
Ø [mm]	6,2	6,2
REF Typ A (17°)	21.478.50.000	21.479.50.000
Preis [EUR]	75,-	75,-

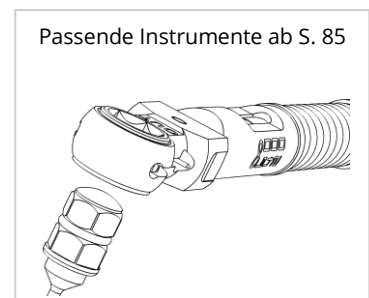

Massivabutments

Titan Grade 5, unsteril, inkl. 2 Schrauben / Drehmoment: 20 Ncm

[KLICK ZUM WEBSHOP](#)



Plattform	3,8	4,3	5,0
H [mm]	11	11	11
Ø [mm]	5,3	5,8	6,5
REF	21.504.38.000	21.505.43.000	21.506.50.000
Preis [EUR]	60,-	60,-	60,-

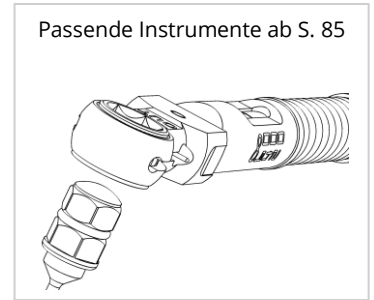

Titanbasen kurz, CAD/CAM

Titan Grade 5, unsteril, inkl. Schraube / Drehmoment: 20 Ncm / kompatibel mit: Exocad® & 3shape®



Plattform	3,3	3,8	4,3	5,0	6,0
GH [mm]	0,3	0,3	0,3	0,3	0,3
H [mm]	4	4	4	4	4
Ø [mm]	3,7	4,1	4,7	5,4	6,4
REF Typ B	21.523.33.000	21.524.38.000	21.525.43.000	21.526.50.000	21.527.60.000
Preis [EUR]	45,-	45,-	45,-	45,-	45,-

Titanbasen lang, CAD/CAM

Titan Grade 5, unsteril, inkl. Schraube / Drehmoment: 20 Ncm / kompatibel mit: Exocad® & 3shape®

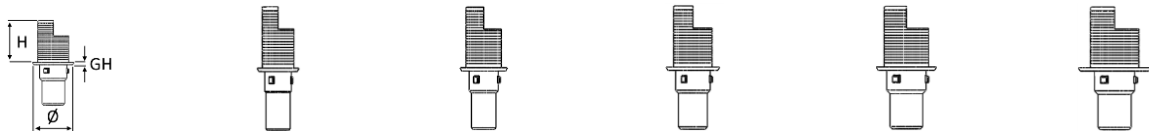

Plattform	3,3	3,8	4,3	5,0	6,0
GH [mm]	0,3	0,3	0,3	0,3	0,3
H [mm]	5,5	5,5	5,5	5,5	5,5
Ø [mm]	3,7	4,1	4,7	5,4	6,4
REF Typ B	21.533.33.000	21.534.38.000	21.535.43.000	21.536.50.000	21.537.60.000
Preis [EUR]	45,-	45,-	45,-	45,-	45,-

Titanbasen nicht indexiert, CAD/CAM

Titan Grade 5, unsteril, inkl. Schraube / Drehmoment: 20 Ncm / ohne Rotationsschutz / kompatibel mit: Exocad® & 3shape®

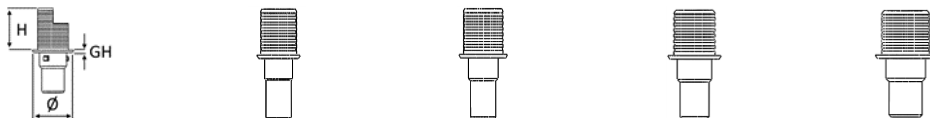

[Per Klick zum Webshop](#)

Plattform	3,3	3,8	4,3	5,0
GH [mm]	0,3	0,3	0,3	0,3
H [mm]	4	4	4	4
Ø [mm]	3,7	4,1	4,7	5,4
REF	21.543.33.000	21.544.38.000	21.545.43.000	21.546.50.000
Preis [EUR]	40,-	40,-	40,-	40,-

Scanbodys

Titan Grade 4, unsteril, inkl. Schraube / Drehmoment: Handfest



Scanbodys sind wieder
aufbereitbar und für
den intraoralen
Einsatz geeignet.

Plattform	3,3	3,8	4,3	5,0 / 6,0
REF	21.552.33.000	21.553.38.000	21.554.43.000	21.555.50.000
Preis [EUR]	30,-	30,-	30,-	30,-

Pre-Mill Abutments

Titan Grade 5, unsteril, inkl. Schraube / Drehmoment: 20 Ncm, kompatibel zum Medentika®-Halter

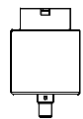
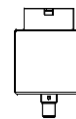
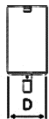

Plattform	3,3	3,8	4,3	5,0 / 6,0
Ø [mm]	11,5	11,5	15,8	15,8
REF	25.065.11.000	25.073.11.000	25.083.15.000	25.091.15.000
Preis [EUR]	37,-	37,-	37,-	37,-

Multi-Unit Abutments 3,8

Titan Grade 5, unsteril / Drehmoment: 30 Ncm



[Per Klick zum Webshop](#)

Plattform	3,8	3,8	3,8
GH [mm]	0,5	2,0	4,0
REF	21.558.38.005	21.559.38.020	21.560.38.040
Preis [EUR]	49,-	49,-	49,-

Multi-Unit Abutments 4,3 / 5,0

Titan Grade 5, unsteril / Drehmoment: 30 Ncm



Plattform	4,3	4,3	4,3	5,0	5,0	5,0
GH [mm]	0,5	2,0	4,0	0,5	2,0	4,0
REF	21.561.43.005	21.562.43.020	21.563.43.040	21.564.50.005	21.565.50.020	21.566.50.040
Preis [EUR]	49,-	49,-	49,-	49,-	49,-	49,-

Multi-Unit Zubehör

Titan Grade 5, unsteril, Anschluss: Hex 1,26

[KLICK ZUM WEBSHOP](#)

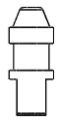

**Titanbasis
Multi-Unit,
CAD/CAM**

**Titankappe
Multi-Unit**

**Verschlusskappe
Multi-Unit**

**Scanbody
Multi-Unit**

**Abformpfosten
Multi-Unit
(offene
Abformung)**

**Laboranalog
Multi-Unit**

<i>Material</i>	Titan Grade 5	Titan Grade 5	Titan Grade 5	Titan Grade 4	Titan Grade 5	Titan Grade 5
<i>inkl. Schraube</i>	ja	ja	nein	ja	ja	nein
<i>Drehmoment</i>	15 Ncm	15 Ncm	Handfest	Handfest	Handfest	-
<i>REF</i>	21.098.42.000	21.096.30.000	21.093.45.037	21.182.00.000	23.019.00.000	24.048.45.100
<i>Preis [EUR]</i>	39,-	39,-	18,-	30,-	26,-	12,-

Abformpfosten kurz (offene Abformung)

Titan Grade 5, unsteril, inkl. Schraube, farbcodiert / Drehmoment: Handfest

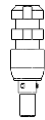
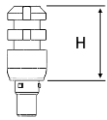

Plattform	3,3	3,8	4,3	5,0
<i>H [mm]</i>	11	11	11	11
<i>Farbcodierung</i>	keine	gelb	rot	blau
<i>REF</i>	23.058.33.000	23.059.38.000	23.060.43.000	23.061.50.000
<i>Preis [EUR]</i>	26,-	26,-	26,-	26,-

Abformpfosten lang (offene Abformung)

Titan Grade 5, unsteril, inkl. Schraube, farbcodiert / Drehmoment: Handfest

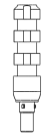
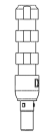
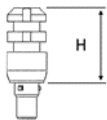

[Per Klick zum Webshop](#)

Plattform	3,3	3,8	4,3	5,0
<i>H [mm]</i>	17	17	17	17
<i>Farbcodierung</i>	keine	gelb	rot	blau
<i>REF</i>	23.070.33.000	23.071.38.000	23.072.43.000	23.073.50.000
<i>Preis [EUR]</i>	26,-	26,-	26,-	26,-

Heli-Loc (Deckprothesen Abutment)

Titan Grade 5 mit TiN-Beschichtung, unsteril, Drehmoment: 30 Ncm

[KLICK ZUM WEBSHOP](#)

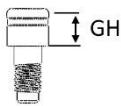

Plattform	3,8	3,8	3,8	3,8
GH [mm]	1	2	3	4
REF	26.159.38.010	26.160.38.020	26.161.38.030	26.162.38.040
Preis [EUR]	59,-	59,-	59,-	59,-

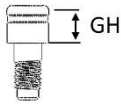

Plattform	4,3	4,3	4,3	4,3
GH [mm]	1	2	3	4
REF	26.164.43.010	26.165.43.020	26.166.43.030	26.167.43.040
Preis [EUR]	59,-	59,-	59,-	59,-

Zubehör zu den Heli-Loc Abutments auf Seite 81

Gingivaformer

Titan Grade 5, unsteril, lasermarkiert / Drehmoment: Handfest

[KLICK ZUM WEBSHOP](#)

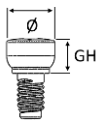

Plattform	3,3	3,3	3,3	3,8	3,8	3,8
GH [mm]	3	4	5	3	4	5
Ø [mm]	4,5	4,5	4,5	4,9	4,9	4,9
REF	21.281.33.030	21.282.33.040	21.283.33.050	21.284.38.030	21.285.38.040	21.286.38.050
Preis [EUR]	18,-	18,-	18,-	18,-	18,-	18,-

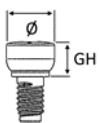

Plattform	4,3	4,3	4,3	5,0	5,0	5,0
GH [mm]	3	4	5	3	4	5
Ø [mm]	5,5	5,5	5,5	6,2	6,2	6,2
REF	21.287.43.030	21.288.43.040	21.289.43.050	21.290.50.030	21.291.50.040	21.292.50.050
Preis [EUR]	18,-	18,-	18,-	18,-	18,-	18,-

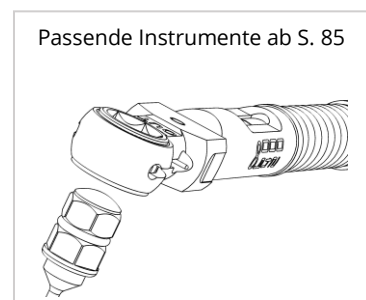
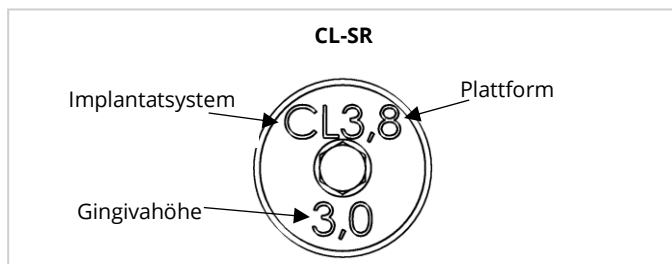

CL-CO Serie - kompatibel zu Altatec® (Camlog®) - Conelog®

CL-CO Serie - kompatibel zu **Altatec® (Camlog®) - Conelog®**

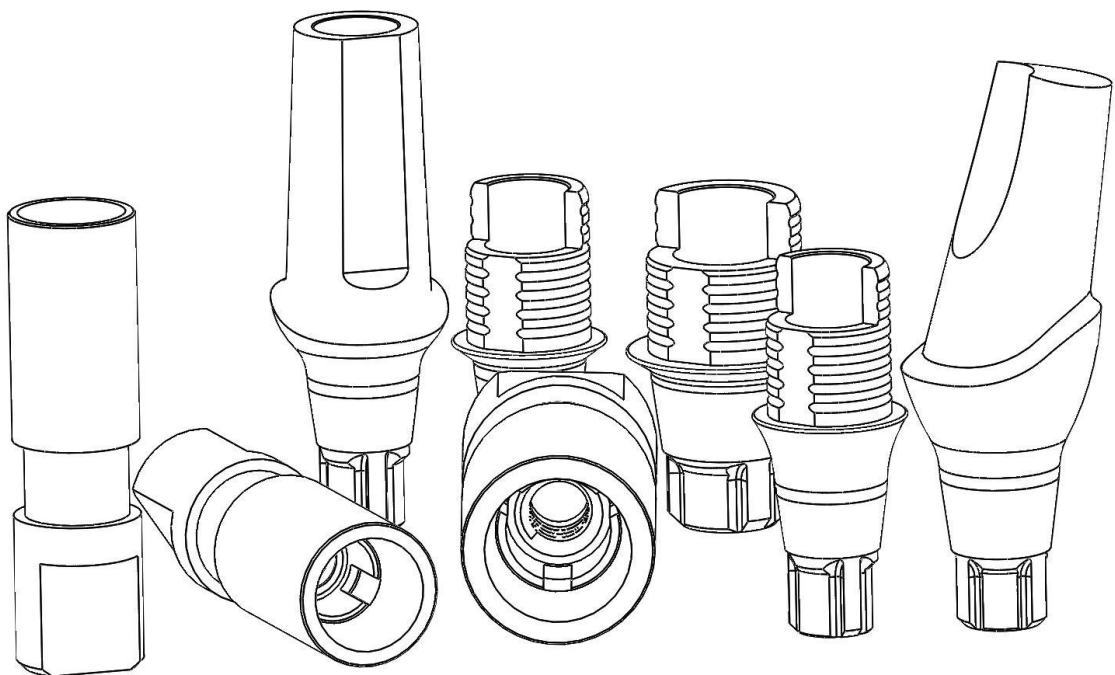

Abutmentschrauben

Titan Grade 5, unsteril, Anschluss: Hex 1,26



Plattform	3,3 / 3,8 / 4,3	5,0	Multi-Unit
Größe	M 1,6	M 2,0	M 1,4
REF	22.311.16.089	22.312.20.089	21.094.21.035
Preis [EUR]	10,-	10,-	10,-

Laborschrauben

Titan Grade 5, unsteril, Anschluss: Hex 1,26, farbcodiert gelb/ Drehmoment: Handfest



[KLICK ZUM WEBSHOP](#)

Plattform	3,3 / 3,8 / 4,3	5,0	Multi-Unit
Größe	M 1,6	M 2,0	M 1,4
REF	24.071.16.089	24.094.20.089	24.107.21.035
Preis [EUR]	6	6	6
ab 5 Stk.	4	4	4
ab 10 Stk.	3,5	3,5	3,5

Laboranaloge

Titan Grade 5, unsteril, farbcodiert, für 3D Druck geeignet

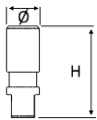

[KLICK ZUM WEBSHOP](#)

Plattform	3,3	3,8	4,3	5,0
H [mm]	12	12	12	12
Ø [mm]	3,3	3,8	4,3	5,0
REF	24.069.33.010	24.070.00.010	24.105.43.120	24.082.50.120
Farbcodierung	keine	gelb	rot	blau
Preis [EUR]	12,-	12,-	12,-	12,-
ab 10 Stk.	9,-	9,-	9,-	9,-
ab 30 Stk.	8,-	8,-	8,-	8,-

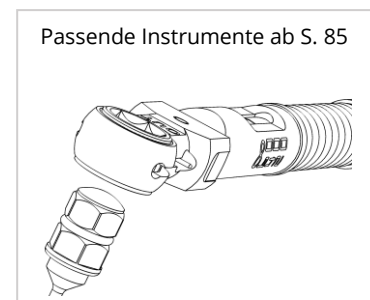
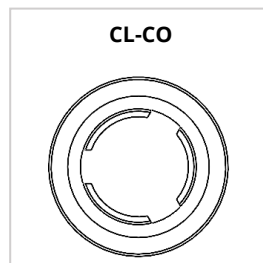

Gerade Abutments

Titan Grade 5, unsteril, inkl. Schraube / Drehmoment: 20 Ncm

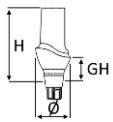

[KLICK ZUM WEBSHOP](#)

Plattform	3,8	3,8	4,3	4,3	5,0	5,0
GH [mm]	1,5	3,0	1,5	3,0	1,5	3,0
H [mm]	8	9,5	8	9,5	8	9,5
Ø [mm]	5,4	5,5	5,9	5,9	6,8	6,8
REF	22.337.38.000	22.338.38.000	22.339.43.000	22.340.43.000	22.341.50.000	22.342.50.000
Preis [EUR]	60,-	60,-	60,-	60,-	60,-	60,-

Gewinkelte Abutments

Titan Grade 5, unsteril, inkl. Schraube / Drehmoment: 20 Ncm

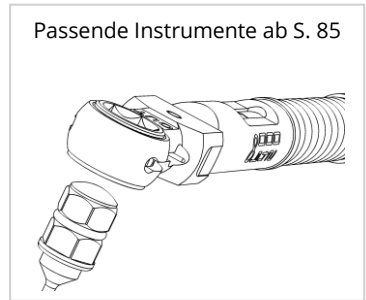
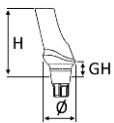

Plattform	3,8/4,3	3,8/4,3
GH [mm]	1,5	3,0
H [mm]	9,5	11
Ø [mm]	5,5	5,3
REF Typ A (17°)	22.349.38.000	22.350.38.000
Preis [EUR]	75,-	75,-



Titanbasen kurz, CAD/CAM

Titan Grade 5, unsteril, inkl. Schraube / Drehmoment: 20 Ncm / kompatibel mit: Exocad® & 3shape®

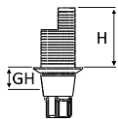

[Per Klick zum Webshop](#)

Plattform	3,3	3,8/4,3	5,0
GH [mm]	1	1	1
H [mm]	4	4	4
REF Typ A	22.394.33.000	22.395.00.000	22.396.50.000
Preis [EUR]	45,-	45,-	45,-

Titanbasen lang, CAD/CAM

Titan Grade 5, unsteril, inkl. Schraube / Drehmoment: 20 Ncm / kompatibel mit: Exocad® & 3shape®

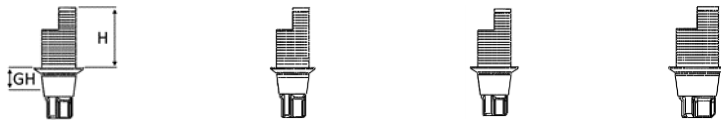

Plattform	3,3	3,8/4,3	5,0
GH [mm]	1	1	1
H [mm]	5,5	5,5	5,5
REF Typ A	22.400.33.000	22.401.00.000	22.402.50.000
Preis [EUR]	45,-	45,-	45,-

Passende Instrumente ab S. 85

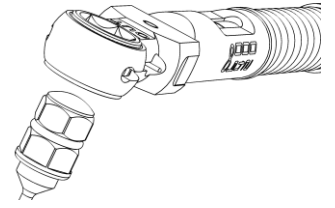

Titanbasen nicht indexiert, CAD/CAM

Titan Grade 5, unsteril, inkl. Schraube / Drehmoment: 20 Ncm / ohne Rotationsschutz / kompatibel mit: Exocad® & 3shape®

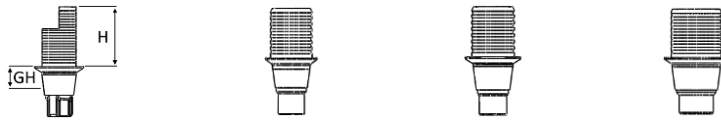

Plattform	3,3	3,8/4,3	5,0
GH [mm]	1	1	1
H [mm]	4	4	4
REF	22.418.33.000	22.419.00.000	22.420.50.000
Preis [EUR]	40,-	40,-	40,-

 [Per Klick zum Webshop](#)

Scanbodys

Titan Grade 4, unsteril, inkl. Schraube / Drehmoment: Handfest



Scanbodys sind wieder aufbereitbar und für den intraoralen Einsatz geeignet.

Plattform	3,3	3,8/4,3	5,0
REF	22.424.33.000	22.425.00.000	22.426.50.000
Preis [EUR]	30,-	30,-	30,-

Pre-Mill Abutments

Titan Grade 5, unsteril, inkl. Schraube / Drehmoment: 20 Ncm, kompatibel zum Medentika®-Halter



Plattform	3,3	3,8 / 4,3	5,0
Ø [mm]	11,5	11,5	15,8
REF	25.188.11.000	25.196.11.000	25.206.15.000
Preis [EUR]	37,-	37,-	37,-

Multi-Unit Abutments

Titan Grade 5, unsteril / Drehmoment: 20 Ncm



Plattform	3,8 / 4,3	3,8 / 4,3	3,8 / 4,3	5,0	5,0	5,0
GH [mm]	1,0	2,5	4,0	1,0	2,5	4,0
REF	22.429.00.010	22.430.00.025	22.431.00.040	22.432.50.010	22.433.50.025	22.434.50.040
Preis [EUR]	49,-	49,-	49,-	49,-	49,-	49,-

Multi-Unit Zubehör

Titan Grade 5, unsteril, Anschluss: Hex 1,26



**Titanbasis
Multi-Unit,
CAD/CAM**

**Titankappe
Multi-Unit**

**Verschlusskappe
Multi-Unit**

**Scanbody
Multi-Unit**

**Abformpfosten
Multi-Unit
(offene
Abformung)**

**Laboranalog
Multi-Unit**

	Titanbasis Multi-Unit, CAD/CAM	Titankappe Multi-Unit	Verschlusskappe Multi-Unit	Scanbody Multi-Unit	Abformpfosten Multi-Unit (offene Abformung)	Laboranalog Multi-Unit
Material	Titan Grade 5	Titan Grade 5	Titan Grade 5	Titan Grade 4	Titan Grade 5	Titan Grade 5
inkl. Schraube	ja	ja	nein	ja	ja	nein
Drehmoment	15 Ncm	15 Ncm	Handfest	Handfest	Handfest	-
REF	21.098.42.000	21.096.30.000	21.093.45.037	21.182.00.000	23.019.00.000	24.048.45.100
Preis [EUR]	39,-	39,-	18,-	30,-	26,-	12,-

Abformpfosten kurz (offene Abformung)

Titan Grade 5, unsteril, inkl. Schraube, farbcodiert / Drehmoment: Handfest

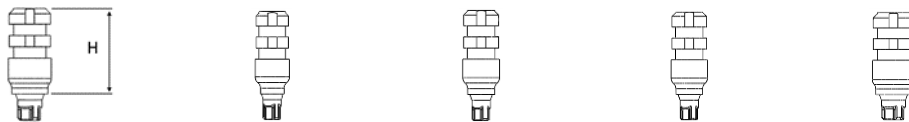

Plattform	3,3	3,8	4,3	5,0
H [mm]	11	11	11	11
Farbcodierung	keine	gelb	rot	blau
REF	23.161.33.000	23.162.00.000	23.193.43.000	23.163.50.000
Preis [EUR]	26,-	26,-	26,-	26,-

Abformpfosten lang (offene Abformung)

Titan Grade 5, unsteril, inkl. Schraube, farbcodiert / Drehmoment: Handfest

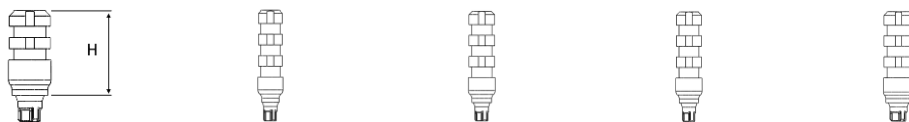

Plattform	3,3	3,8	4,3	5,0
H [mm]	17	17	17	17
Farbcodierung	keine	gelb	rot	blau
REF	23.168.33.000	23.169.00.000	23.195.43.000	23.170.50.000
Preis [EUR]	26,-	26,-	26,-	26,-



Heli-Loc (Deckprothesen Abutment)

Titan Grade 5 mit TiN-Beschichtung, unsteril, Drehmoment: 20 Ncm



Plattform	3,8 / 4,3	3,8 / 4,3	3,8 / 4,3	3,8 / 4,3
GH [mm]	1	2	3	4
REF	26.178.38.010	26.179.38.020	26.180.38.030	26.181.38.040
Preis [EUR]	59,-	59,-	59,-	59,-

Zubehör zu den Heli-Loc Abutments auf Seite 81

Gingivaformer

Titan Grade 5, unsteril, lasermarkiert / Drehmoment: Handfest



Plattform	3,3	3,3	3,3	3,8	3,8	3,8
GH [mm]	3	4	5	3	4	5
Ø [mm]	3,9	3,9	3,9	4,5	4,5	4,5
REF	22.774.33.030	22.775.33.040	22.776.33.050	22.777.38.030	22.778.38.040	22.779.38.050
Preis [EUR]	18,-	18,-	18,-	18,-	18,-	18,-



Plattform	4,3	4,3	4,3	5,0	5,0	5,0
GH [mm]	3	4	5	3	4	5
Ø [mm]	5,0	5,0	5,0	5,7	5,7	5,7
REF	22.780.43.030	22.781.43.040	22.782.43.050	22.783.50.030	22.784.50.040	22.785.50.050
Preis [EUR]	18,-	18,-	18,-	18,-	18,-	18,-

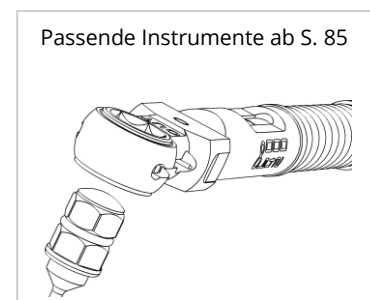
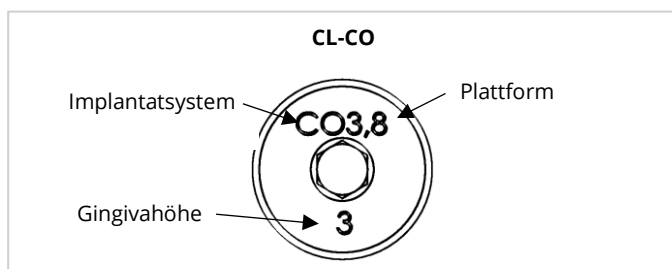

AT-TX Serie - kompatibel zu Dentsply® - Astra Tech® OsseoSpeed™ TX

AT-TX Serie - kompatibel zu **Dentsply® - Astra Tech®**
OsseoSpeed™ TX

 **heliocos**
compatible to
Astra Tech®

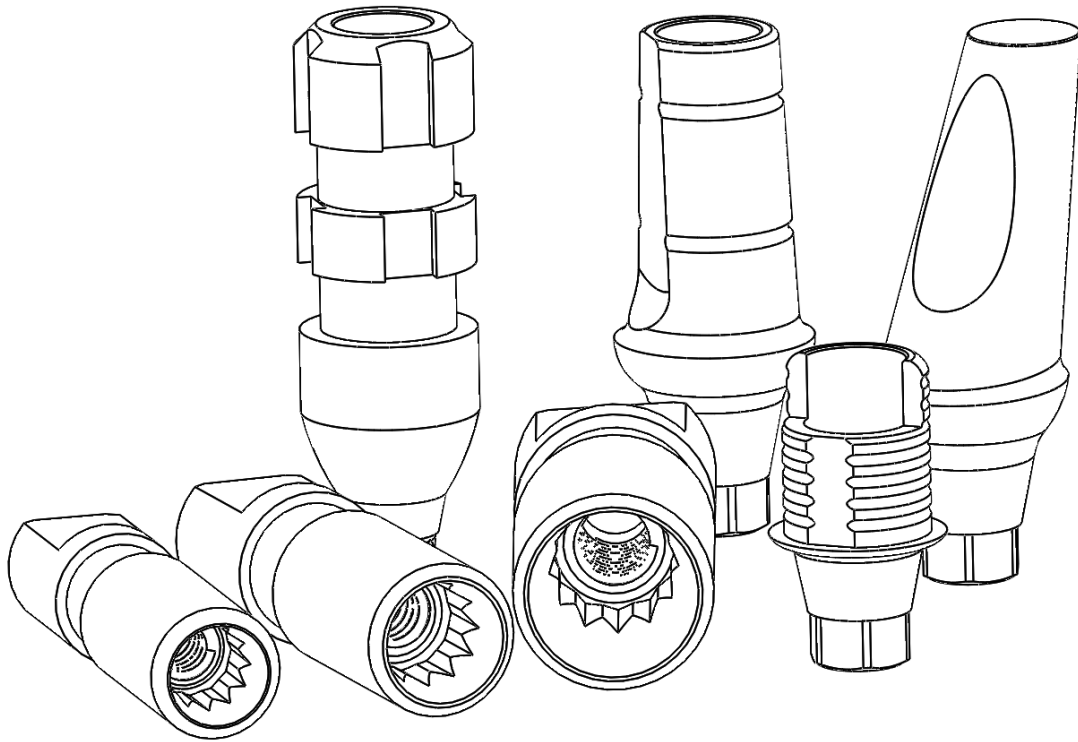

Abutmentschrauben

Titan Grade 5, unsteril, Anschluss: Hex 1,26



Plattform	3,0	3,5 / 4,0	4,5 / 5,0	Multi-Unit
Größe	M 1,4	M 1,6	M 2,0	M 1,4
REF	21.339.30.014	21.340.00.016	21.341.00.020	21.094.21.035
Preis [EUR]	10,-	10,-	10,-	10,-

Laborschrauben

Titan Grade 5, unsteril, Anschluss: Hex 1,26, farbcodiert gelb/ Drehmoment: Handfest



Plattform	3,0	3,5 / 4,0	4,5 / 5,0	Multi-Unit
Größe	M 1,4	M 1,6	M 2,0	M 1,4
REF	24.017.30.075	24.018.00.080	24.019.00.095	24.107.21.035
Preis [EUR]	6,-	6,-	6,-	6,-
ab 5 Stk.	4,-	4,-	4,-	4,-
ab 10 Stk.	3,50	3,50	3,50	3,50

Laboranaloge

Titan Grade 5, unsteril, farbcodiert, für 3D Druck geeignet

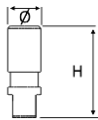

[KLICK ZUM WEBSHOP](#)

Plattform	3,0	3,5 / 4,0	4,5 / 5,0
H [mm]	12	12	12
Ø [mm]	3,0	3,5	4,5
Farbcodierung	gelb	türkis	lila
REF	24.014.30.010	24.015.00.010	24.016.00.010
Preis [EUR]	12,-	12,-	12,-
Ab 10 Stk.	9,-	9,-	9,-
Ab 30 Stk.	8,-	8,-	8,-

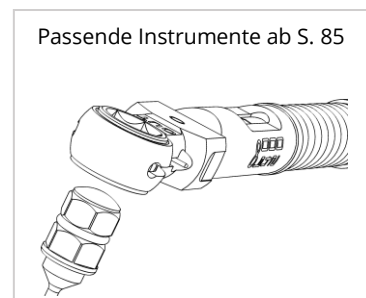
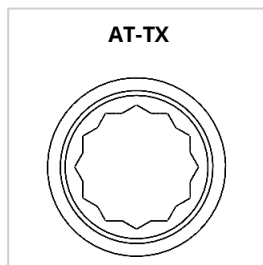

Gerade Abutments

Titan Grade 5, unsteril, inkl. Schraube

3,0: Drehmoment: 15 Ncm

3,5/4,0 und 4,5/5,0: Drehmoment: 25 Ncm

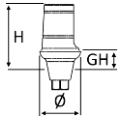

[KLICK ZUM WEBSHOP](#)



Plattform	3,0	3,0	3,5 / 4,0	3,5 / 4,0
GH [mm]	1,5	2,5	2	4
H [mm]	7	8	9	10
Ø [mm]	4	4	4,5	4,5
REF	21.360.30.000	21.361.30.000	21.362.00.000	21.364.00.000
Preis [EUR]	60,-	60,-	60,-	60,-

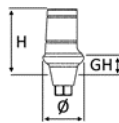

Passende Instrumente ab S. 85

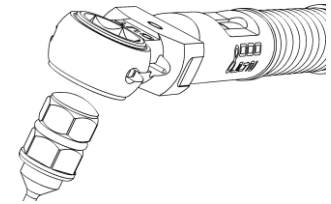

Plattform	4,5 / 5,0	4,5 / 5,0
GH [mm]	2	4
H [mm]	9	10
Ø [mm]	6	6
REF	21.366.00.000	21.367.00.000
Preis [EUR]	60,-	60,-

Gewinkelte Abutments

Titan Grade 5, unsteril, inkl. Schraube

3,0: Drehmoment: 15 Ncm

3,5/4,0 und 4,5/5,0: Drehmoment: 25 Ncm

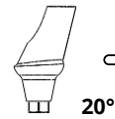
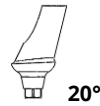
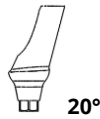
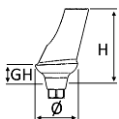

[Per Klick zum Webshop](#)

Plattform	3,0	3,5 / 4,0	3,5 / 4,0	4,5 / 5,0
GH [mm]	2,5	2	2	2
H [mm]	7,5	9,5	9,5	9,5
Ø [mm]	4	4,5	5,5	6
REF	21.372.30.000	21.373.00.000	21.374.00.000	21.375.00.000
Preis [EUR]	75,-	75,-	75,-	75,-

Titanbasen kurz, CAD/CAM

Titan Grade 5, unsteril, inkl. Schraube / kompatibel mit: Exocad® & 3shape®

3,0: Drehmoment: 15 Ncm

3,5/4,0 und 4,5/5,0: Drehmoment: 25 Ncm

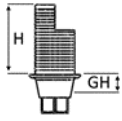

[KLICK ZUM WEBSHOP](#)

Plattform	3,0	3,5 / 4,0	4,5 / 5,0
GH [mm]	0,6	0,6	0,6
H [mm]	4	4	4
REF	21.387.30.000	21.388.00.000	21.389.00.000
Preis [EUR]	45,-	45,-	45,-

Titanbasen lang, CAD/CAM

Titan Grade 5, unsteril, inkl. Schraube / kompatibel mit: Exocad® & 3shape®

3,0: Drehmoment: 15 Ncm

3,5/4,0 und 4,5/5,0: Drehmoment: 25 Ncm

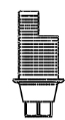
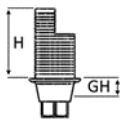

Plattform	3,0	3,5 / 4,0	4,5 / 5,0
GH [mm]	0,6	0,6	0,6
H [mm]	5,5	5,5	5,5
REF	21.393.30.000	21.394.00.000	21.395.00.000
Preis [EUR]	45,-	45,-	45,-

Titanbasen nicht indexiert, CAD/CAM

Titan Grade 5, unsteril, inkl. Schraube / Drehmoment: 25 Ncm / ohne Rotationsschutz / kompatibel mit: Exocad® & 3shape®

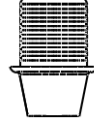
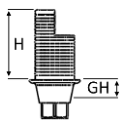

[Per Klick zum Webshop](#)

Plattform	3,5 / 4,0	4,5 / 5,0
GH [mm]	0,6	0,6
H [mm]	4	4
REF	21.398.00.000	21.399.00.000
Preis [EUR]	40,-	40,-

Passende Instrumente ab S. 85

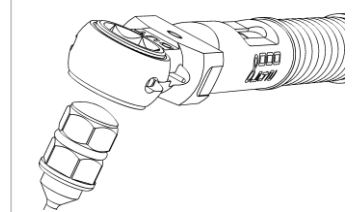

Scanbodys

Titan Grade 4, unsteril, inkl. Schraube / Drehmoment: Handfest



Scanbodys sind wieder
aufbereitbar und für den
intraoralen Einsatz geeignet.

Plattform	3,0	3,5 / 4,0	4,5 / 5,0
REF	21.403.30.000	21.404.00.000	21.405.00.000
Preis [EUR]	30,-	30,-	30,-

Pre-Mill Abutments

Titan Grade 5, unsteril, inkl. Schraube / Drehmoment: 25 Ncm, kompatibel zum Medentika®-Halter

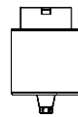
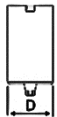

Plattform	3,5 / 4,0	4,5 / 5,0
Ø [mm]	11,5	15,8
REF	25.049.11.000	25.059.15.000
Preis [EUR]	37,-	37,-

Multi-Unit Abutments D3,5 / 4,0

Titan Grade 5, unsteril / Drehmoment: 25 Ncm

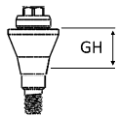

[KLICK ZUM
WEBSHOP](#)

Plattform	3,5 / 4,0	3,5 / 4,0	3,5 / 4,0	3,5 / 4,0
GH [mm]	1,5	2,5	3,5	4,5
REF	21.407.00.015	21.408.00.025	21.409.00.035	21.410.00.045
Preis [EUR]	49,-	49,-	49,-	49,-

Multi-Unit Abutments D4,5 / 5,0

Titan Grade 5, unsteril / Drehmoment: 25 Ncm

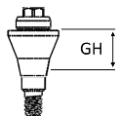

[Per Klick zum Webshop](#)

Plattform	4,5 / 5,0	4,5 / 5,0	4,5 / 5,0	4,5 / 5,0
GH [mm]	1,5	2,5	3,5	4,5
REF	21.412.00.015	21.413.00.025	21.414.00.035	21.415.00.045
Preis [EUR]	49,-	49,-	49,-	49,-

Passende Instrumente ab S. 85

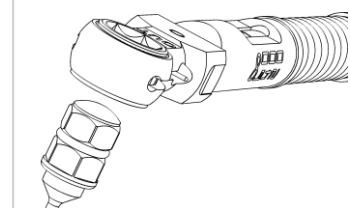

Multi-Unit Zubehör

Titan Grade 5, unsteril, Anschluss: Hex 1,26



Titanbasis Multi-Unit, CAD/CAM **Titankappe Multi-Unit** **Verschlusskappe Multi-Unit** **Scanbody Multi-Unit** **Abformpfosten Multi-Unit (offene Abformung)** **Laboranalog Multi-Unit**

<i>Material</i>	Titan Grade 5	Titan Grade 5	Titan Grade 5	Titan Grade 4	Titan Grade 5	Titan Grade 5
<i>inkl. Schraube</i>	ja	ja	nein	ja	ja	nein
<i>Drehmoment</i>	15 Ncm	15 Ncm	Handfest	Handfest	Handfest	-
<i>REF</i>	21.098.42.000	21.096.30.000	21.093.45.037	21.182.00.000	23.019.00.000	24.048.45.100
<i>Preis [EUR]</i>	39,-	39,-	18,-	30,-	26,-	12,-

Abformpfosten kurz (offene Abformung)

Titan Grade 5, unsteril, inkl. Schraube, farbcodiert / Drehmoment: Handfest



Plattform	3,0	3,5 / 4,0	4,5 / 5,0
<i>H [mm]</i>	11	11	11
<i>Farbcodierung</i>	gelb	türkis	lila
<i>REF</i>	23.039.30.000	23.040.00.000	23.041.00.000
<i>Preis [EUR]</i>	26,-	26,-	26,-

Abformpfosten lang (offene Abformung)

Titan Grade 5, unsteril, inkl. Schraube, farbcodiert / Drehmoment: Handfest



KLICK ZUM WEBSHOP

Plattform	3,0	3,5 / 4,0	4,5 / 5,0
<i>H [mm]</i>	16,5	16,5	16,5
<i>Farbcodierung</i>	gelb	türkis	lila
<i>REF</i>	23.048.30.000	23.049.00.000	23.050.00.000
<i>Preis [EUR]</i>	26,-	26,-	26,-

Heli-Loc (Deckprothesen Abutment)

Titan Grade 5 mit TiN-Beschichtung, unsteril, Drehmoment: 25 Ncm

[KLICK ZUM WEBSHOP](#)

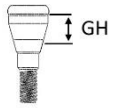

Plattform	3,5 / 4,0	3,5 / 4,0	3,5 / 4,0	3,5 / 4,0
GH [mm]	1	2	3	4
REF	26.145.35.010	26.146.35.020	26.147.35.030	26.148.35.040
Preis [EUR]	59,-	59,-	59,-	59,-

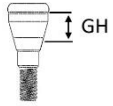

Plattform	4,5 / 5,0	4,5 / 5,0	4,5 / 5,0	4,5 / 5,0
GH [mm]	1	2	3	4
REF	26.150.45.010	26.151.45.020	26.152.45.030	26.153.45.040
Preis [EUR]	59,-	59,-	59,-	59,-

Zubehör zu den Heli-Loc Abutments auf Seite 81

Gingivaformer

Titan Grade 5, unsteril, inkl. Schraube, lasermarkiert / Drehmoment: Handfest

[KLICK ZUM WEBSHOP](#)

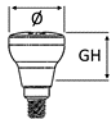

Plattform	3,0	3,0	3,0
GH [mm]	3	4	5
Ø [mm]	4	4	4
REF	22.600.30.030	22.601.30.040	22.602.30.050
Preis [EUR]	18,-	18,-	18,-

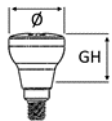

Plattform	3,5 / 4,0	3,5 / 4,0	3,5 / 4,0
GH [mm]	3	4	5
Ø [mm]	4,5	4,5	4,5
REF	22.603.35.030	22.604.35.040	22.605.35.050
Preis [EUR]	18,-	18,-	18,-

AT-TX Serie - kompatibel zu Dentsply® - Astra Tech® OsseoSpeed™ TX

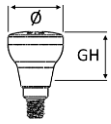

Plattform	4,5 / 5,0	4,5 / 5,0	4,5 / 5,0
GH [mm]	3	4	5
Ø [mm]	5	5	5
REF	22.606.45.030	22.607.45.040	22.608.45.050
Preis [EUR]	18,-	18,-	18,-

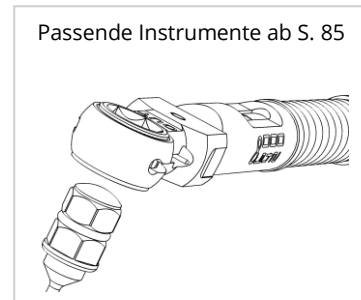
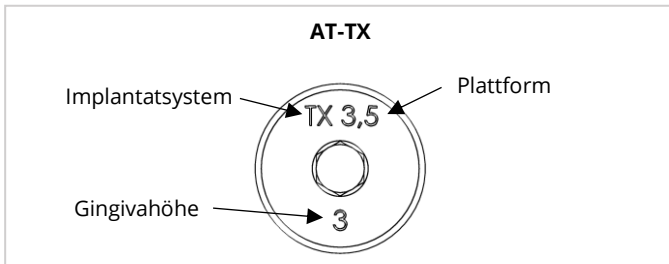

AT-EV Serie - kompatibel zu Dentsply® - Astra Tech® OsseoSpeed™ EV

AT-EV Serie - kompatibel zu **Dentsply® - Astra Tech®**
OsseoSpeed™ EV

 **heliocos**
compatible to
Astra Tech® EV™

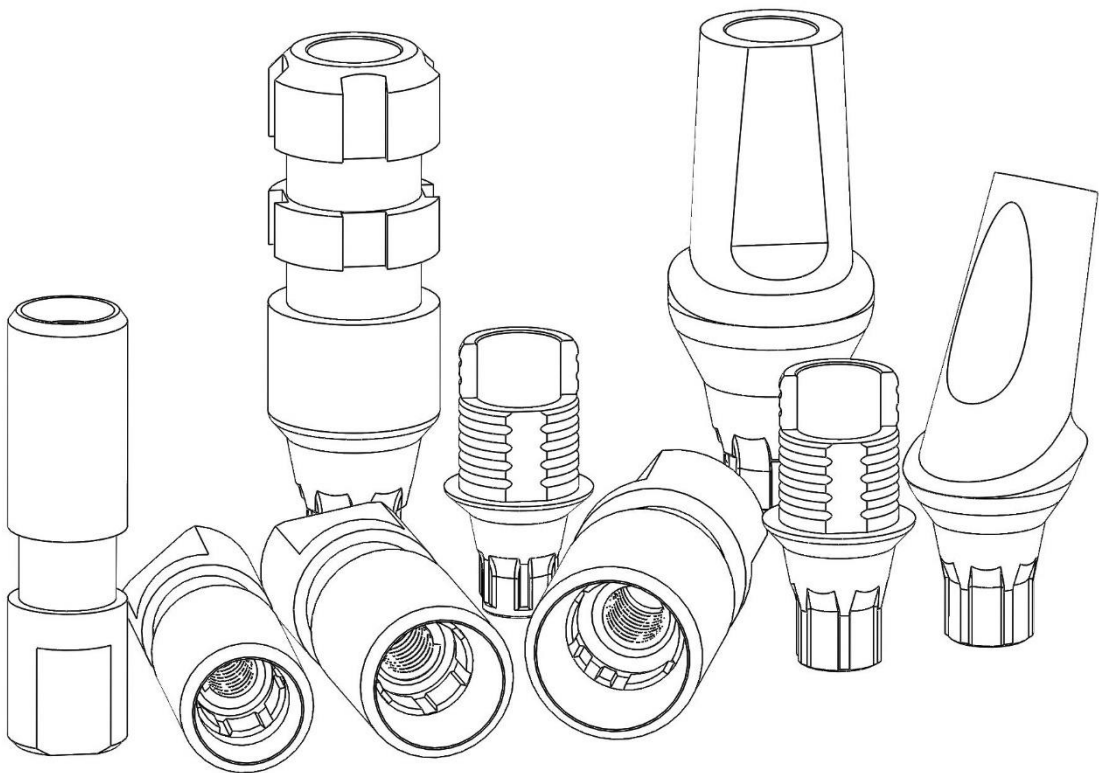

[KLICK ZUM WEBSHOP](#)

Abutmentschrauben

Titan Grade 5, unsteril, Anschluss: Hex 1,26



Plattform	3,0	3,6	4,2	4,8/5,4	Multi-Unit
Größe	M 1,4	M 1,6	M 1,8	M 2,0	M 1,4
REF	22.435.14.076	22.436.16.075	22.437.18.076	22.438.20.076	21.094.21.035
Preis [EUR]	10,-	10	10	10	10

Laborschrauben

Titan Grade 5, unsteril, Anschluss: Hex 1,26, farbcodiert gelb/ Drehmoment: Handfest



Plattform	3,0	3,6	4,2	4,8/5,4	Multi-Unit
Größe	M 1,4	M 1,6	M 1,8	M 2,0	M 1,4
REF	24.096.14.076	24.097.16.075	24.098.18.076	24.099.20.076	24.107.21.035
Preis [EUR]	6,-	6,-	6,-	6,-	6,-
ab 5 Stk.	4,-	4,-	4,-	4,-	4,-
Ab 10 Stk.	3,50	3,50	3,50	3,50	3,50

Laboranaloge

Titan Grade 5, unsteril, farbcodiert, für 3D Druck geeignet

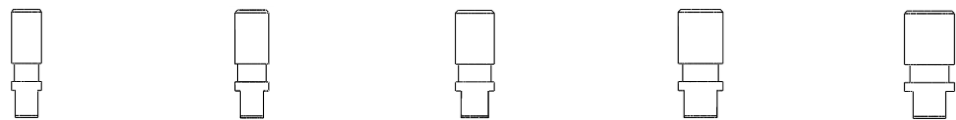
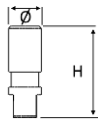

Plattform	3,0	3,6	4,2	4,8	5,4
H [mm]	12	12	12	12	12
REF	24.083.30.120	24.084.36.120	24.085.42.120	24.086.48.120	24.087.54.120
Farbcodierung	grün	lila	gelb	blau	braun
Preis [EUR]	12,-	12,-	12,-	12,-	12,-
ab 10 Stk.	9,-	9,-	9,-	9,-	9,-
Ab 30 Stk.	8,-	8,-	8,-	8,-	8,-

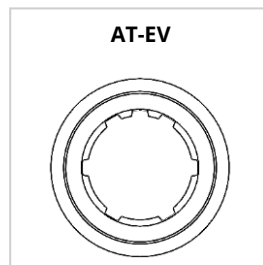

Gerade Abutments

Titan Grade 5, unsteril, inkl. Schraube / Drehmoment: 25 Ncm

[KLICK ZUM WEBSHOP](#)

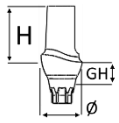

Plattform	3,0	3,0	3,6	4,2
GH [mm]	1,5	2,5	2,5	2,5
H [mm]	7	8	10	10
Ø [mm]	4	4	4,5	5,5
REF	22.476.30.000	22.477.36.000	22.478.36.000	22.479.42.000
Preis [EUR]	60,-	60,-	60,-	60,-

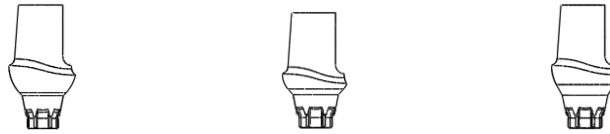
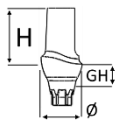

Plattform	4,8	5,4	5,4
GH [mm]	2,5	1,5	2,5
H [mm]	10	9	10
Ø [mm]	7,0	7,0	7,0
REF	22.480.48.000	22.481.54.000	22.482.54.000
Preis [EUR]	60,-	60,-	60,-

Gewinkelte Abutments

Titan Grade 5, unsteril, inkl. Schraube / Drehmoment: 25 Ncm

[KLICK ZUM WEBSHOP](#)

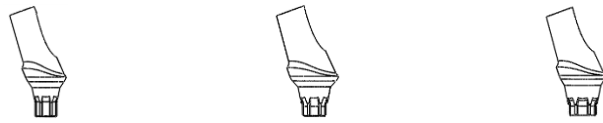
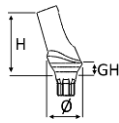

Plattform	3,6	4,2	4,8
GH [mm]	1,5	1,5	1,5
H [mm]	9	9	9
Ø [mm]	4,5	5,5	5,5
REF (20°)	22.488.36.000	22.489.42.000	22.490.48.000
Preis [EUR]	75,-	75,-	75,-

Passende Instrumente ab S. 85

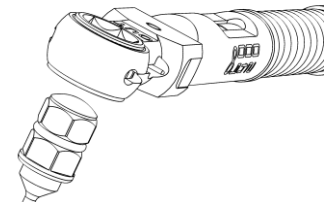

Titanbasen kurz, CAD/CAM

Titan Grade 5, unsteril, inkl. Schraube / Drehmoment: 25 Ncm / kompatibel mit: Exocad® & 3shape®



Plattform	3,0	3,6	4,2	4,8	5,4
GH [mm]	1,0	1,0	1,0	1,0	1,0
H [mm]	4	4	4	4	4
REF	22.514.30.000	22.515.36.000	22.516.42.000	22.517.48.000	22.518.54.000
Preis [EUR]	45,-	45,-	45,-	45,-	45,-

Titanbasen lang, CAD/CAM

Titan Grade 5, unsteril, inkl. Schraube / Drehmoment: 25 Ncm / kompatibel mit: Exocad® & 3shape®



Plattform	3,0	3,6	4,2	4,8	5,4
GH [mm]	1,0	1,0	1,0	1,0	1,0
H [mm]	5,5	5,5	5,5	5,5	5,5
REF	22.524.30.000	22.525.36.000	22.526.42.000	22.527.48.000	22.528.54.000
Preis [EUR]	45,-	45,-	45,-	45,-	45,-

Titanbasen nicht indexiert, CAD/CAM

Titan Grade 5, unsteril, inkl. Schraube / Drehmoment: 25 Ncm / ohne Rotationsschutz / kompatibel mit: Exocad® & 3shape®



Plattform	3,0	3,6	4,2	4,8	5,4
GH [mm]	1,0	1,0	1,0	1,0	1,0
H [mm]	4	4	4	4	4
REF	22.534.30.000	22.535.36.000	22.536.42.000	22.537.48.000	22.538.54.000
Preis [EUR]	40,-	40,-	40,-	40,-	40,-

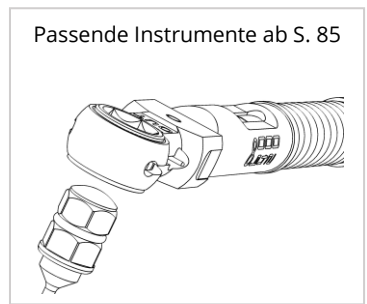

Scanbodys

Titan Grade 4, unsteril, inkl. Schraube / Drehmoment: Handfest

[KLICK ZUM WEBSHOP](#)

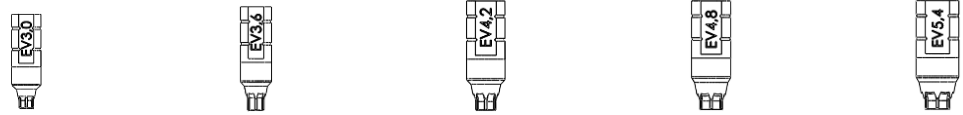

Plattform	3,0	3,6	4,2	4,8	5,4
REF	22.544.30.000	22.545.36.000	22.546.42.000	22.547.48.000	22.548.54.000
Preis [EUR]	30,-	30,-	30,-	30,-	30,-

Pre-Mill Abutments

Titan Grade 5, unsteril, inkl. Schraube / Drehmoment: 25 Ncm, kompatibel zum Medentika®-Halter



Plattform	3,6	4,2	4,8
Ø [mm]	11,5	11,5	15,8
REF	25.216.11.000	25.224.11.000	25.234.15.000
Preis [EUR]	37,-	37,-	37,-

Multi-Unit Abutments D3,6

Titan Grade 5, unsteril / Drehmoment: 25 Ncm

[KLICK ZUM WEBSHOP](#)



Plattform	3,6	3,6	3,6	3,6
GH [mm]	1	2	3	5
REF	22.553.36.010	22.554.36.020	22.555.36.030	22.556.36.050
Preis [EUR]	49,-	49,-	49,-	49,-

Multi-Unit Abutments D4,2

Titan Grade 5, unsteril / Drehmoment: 25 Ncm



Plattform	4,2	4,2	4,2	4,2
GH [mm]	1	2	3	5
REF	22.557.42.010	22.558.42.020	22.559.42.030	22.560.42.050
Preis [EUR]	49,-	49,-	49,-	49,-

Multi-Unit Abutments D4,8

Titan Grade 5, unsteril / Drehmoment: 25 Ncm



Plattform	4,8	4,8	4,8	4,8
GH [mm]	1	2	3	5
REF	22.561.48.010	22.562.48.020	22.563.48.030	22.564.48.050
Preis [EUR]	49,-	49,-	49,-	49,-

Multi-Unit Zubehör

Titan Grade 5, unsteril, Anschluss: Hex 1,26

[KLICK ZUM WEBSHOP](#)



Titanbasis Multi-Unit, CAD/CAM **Titankappe Multi-Unit** **Verschlusskappe Multi-Unit** **Scanbody Multi-Unit** **Abformpfosten Multi-Unit (offene Abformung)** **Laboranalog Multi-Unit**

<i>Material</i>	Titan Grade 5	Titan Grade 5	Titan Grade 5	Titan Grade 4	Titan Grade 5	Titan Grade 5
<i>inkl. Schraube</i>	ja	ja	nein	ja	ja	nein
<i>Drehmoment</i>	15 Ncm	15 Ncm	Handfest	Handfest	Handfest	-
<i>REF</i>	21.098.42.000	21.096.30.000	21.093.45.037	21.182.00.000	23.019.00.000	24.048.45.100
<i>Preis [EUR]</i>	39,-	39,-	18,-	30,-	26,-	12,-

Abformpfosten kurz (offene Abformung)

Titan Grade 5, unsteril, inkl. Schraube, farbcodiert / Drehmoment: Handfest



Plattform 3,0 **3,6** **4,2** **4,8** **5,4**

<i>H [mm]</i>	11	11	11	11	11
<i>Farbcodierung</i>	grün	lila	gelb	blau	braun
<i>REF</i>	23.196.30.000	23.197.36.000	23.198.42.000	23.199.48.000	23.200.54.000
<i>Preis [EUR]</i>	26,-	26,-	26,-	26,-	26,-

Abformpfosten lang (offene Abformung)

Titan Grade 5, unsteril, inkl. Schraube, farbcodiert / Drehmoment: Handfest

[KLICK ZUM WEBSHOP](#)



Plattform 3,0 **3,6** **4,2** **4,8** **5,4**

<i>H [mm]</i>	17	17	17	17	17
<i>Farbcodierung</i>	grün	lila	gelb	blau	braun
<i>REF</i>	23.210.30.000	23.211.36.000	23.212.42.000	23.213.48.000	23.214.54.000
<i>Preis [EUR]</i>	26,-	26,-	26,-	26,-	26,-

Heli-Loc (Deckprothesen Abutment)

Titan Grade 5 mit TiN-Beschichtung, unsteril, Drehmoment: 25 Ncm

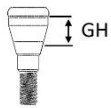

Plattform	3,6	3,6	3,6	3,6
GH [mm]	1	2	3	4
REF	26.130.36.010	26.131.36.020	26.132.36.030	26.133.36.040
Preis [EUR]	59,-	59,-	59,-	59,-

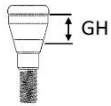

Plattform	4,2	4,2	4,2	4,2
GH [mm]	1	2	3	4
REF	26.135.42.010	26.136.42.020	26.137.42.030	26.138.42.040
Preis [EUR]	59,-	59,-	59,-	59,-

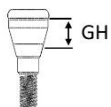

Plattform	4,8	4,8	4,8	4,8
GH [mm]	1	2	3	4
REF	26.140.48.010	26.141.48.020	26.142.48.030	26.143.48.040
Preis [EUR]	59,-	59,-	59,-	59,-

Zubehör zu den Heli-Loc Abutments auf Seite 81

Gingivaformer

Titan Grade 5, unsteril, inkl. Schraube, lasermarkiert / Drehmoment: Handfest

[KLICK ZUM WEBSHOP](#)

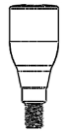
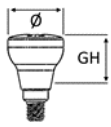

Plattform	3,0	3,0	3,0	3,6	3,6	3,6
GH [mm]	3,5	4,5	6,5	3,5	4,5	6,5
Ø [mm]	4,0	4,0	4,0	4,5	4,5	4,5
REF	22.755.30.035	22.756.30.045	22.757.30.065	22.758.36.035	22.759.36.045	22.760.36.065
Preis [EUR]	18,-	18,-	18,-	18,-	18,-	18,-

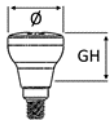

Plattform	4,2	4,2	4,2	4,8	4,8	4,8
GH [mm]	3,5	4,5	6,5	3,5	4,5	6,5
Ø [mm]	5,0	5,0	5,0	6,5	6,5	6,5
REF	22.761.42.035	22.762.42.045	22.763.42.065	22.764.48.035	22.765.48.045	22.767.48.065
Preis [EUR]	18,-	18,-	18,-	18,-	18,-	18,-

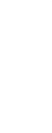
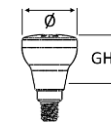

[Per Klick zum Webshop](#)

Plattform	5,4	5,4	5,4
GH [mm]	3,5	4,5	6,5
Ø [mm]	6,5	6,5	6,5
REF	22.768.54.035	22.769.54.045	22.770.54.065
Preis [EUR]	18,-	18,-	18,-

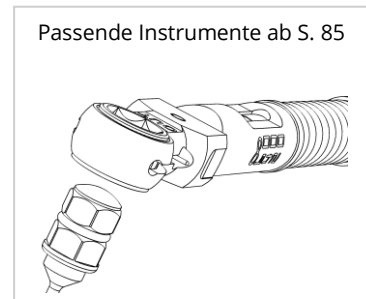
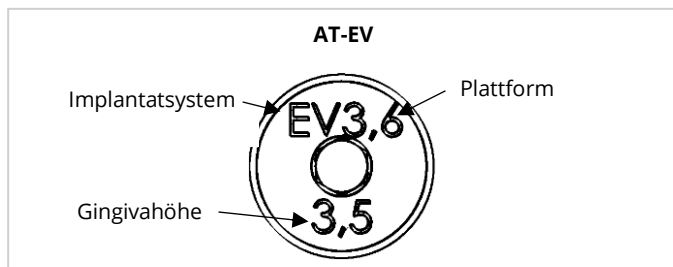

FX Serie - kompatibel zu Dentsply® - Xive® S

FX Serie – kompatibel zu **Dentsply®** – **Xive® S**

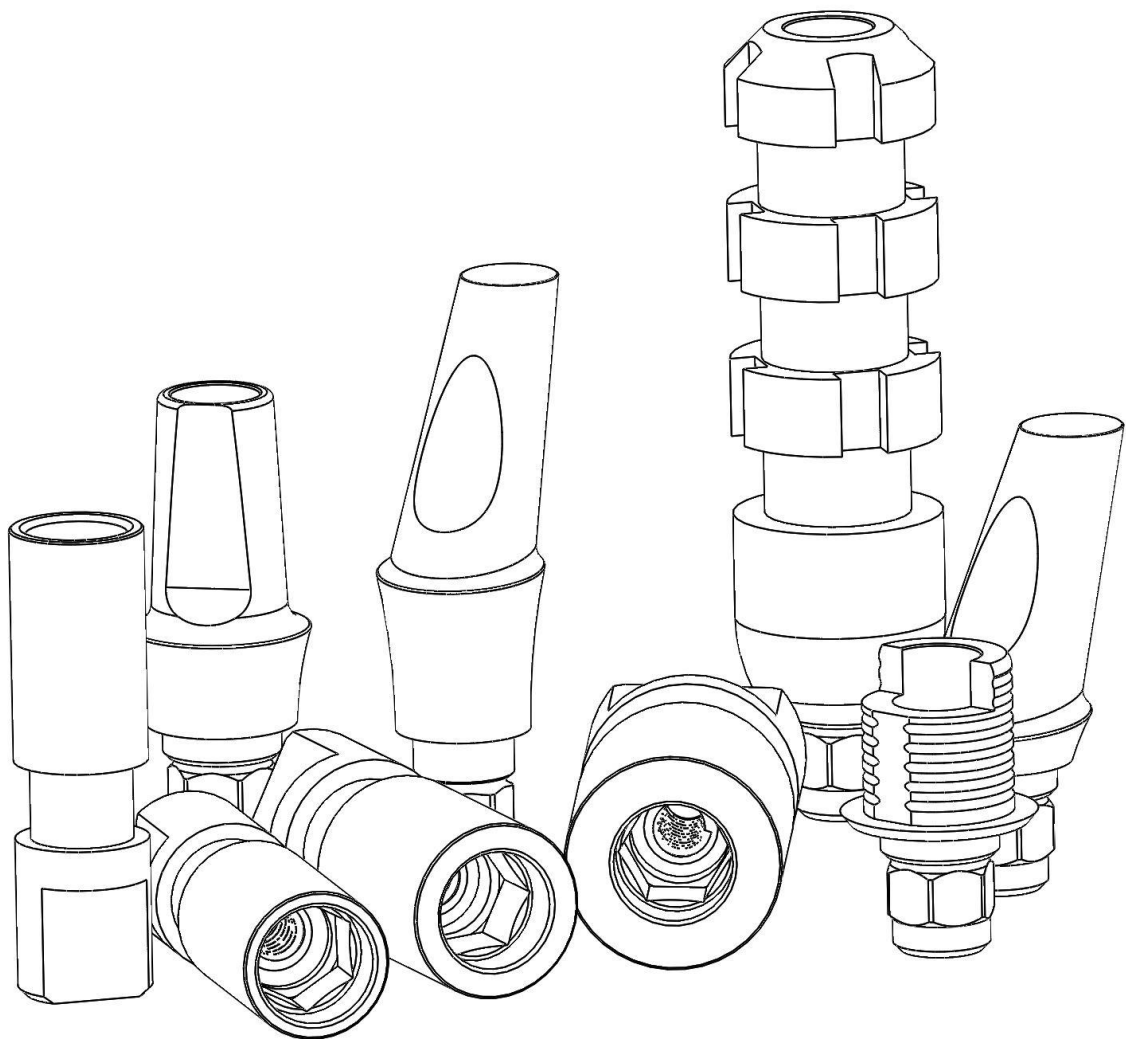

FX Serie - kompatibel zu Dentsply® - Xive® S

Abutmentschrauben

Titan Grade 5, unsteril, Anschluss: Hex 1,22



Passende Instrumente ab S. 85

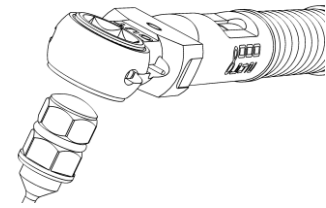

Plattform	3,4 / 3,8 / 4,5 / 5,5	Multi-Unit
Größe	M 1,6	M 1,4
REF	21.577.16.083	21.731.21.035
Preis [EUR]	10,-	10,-

Laborschrauben

Titan Grade 5, unsteril, Anschluss: Hex 1,22, farbcodiert gelb/ Drehmoment: Handfest



[Per Klick zum Webshop](#)

Plattform	3,4 / 3,8 / 4,5 / 5,5	Multi-Unit
Größe	M 1,6	M 1,4
REF	24.024.00.083	24.109.21.035
Preis [EUR]	6,-	6,-
ab 5 Stk.	4,-	4,-
ab 10 Stk.	3,50	3,50

Laboranaloge

Titan Grade 5, unsteril, farbcodiert, für 3D Druck geeignet

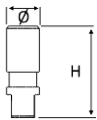

Plattform	3,4	3,8	4,5 / 5,5
H [mm]	12	12	12
Ø [mm]	3,4	3,8	4,5
Farbcodierung	keine	gelb	blau
REF	24.020.34.010	24.021.38.010	24.022.45.010
Preis [EUR]	12,-	12,-	12,-
ab 10 Stk.	9,-	9,-	9,-
ab 30 Stk.	8,-	8,-	8,-

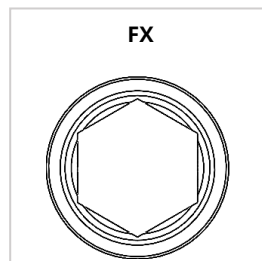

Passende Instrumente ab S. 85

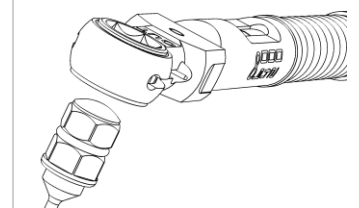

Gerade Abutments

Titan Grade 5, unsteril, inkl. Schraube / Drehmoment: 25 Ncm

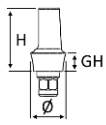

		Plattform	3,4	3,8	4,5	5,5
		H [mm]	6	6	6	6
		Ø [mm]	4,2	4,6	5,3	6,3
REF	GH 1 mm		21.598.34.000	21.601.38.000	21.604.45.000	21.607.55.000
REF	GH 2,5 mm		21.599.34.000	21.602.38.000	21.605.45.000	21.608.55.000
		Preis [EUR]	60,-	60,-	60,-	60,-

Gewinkelte Abutments / 15 Grad

Titan Grade 5, unsteril, inkl. Schraube / Drehmoment: 25 Ncm

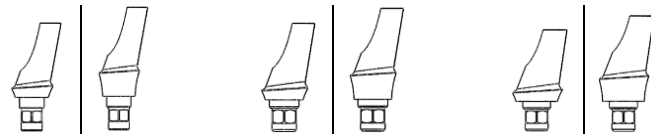
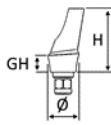

		Plattform	3,4	3,8	4,5
		H [mm]	7	7	7
		Ø [mm]	4,2	4,6	5,3
REF	Typ 1 15°	GH 1 mm	21.622.34.000	21.625.38.000	21.628.45.000
REF	Typ 1 15°	GH 2,5 mm	21.623.34.000	21.626.38.000	21.629.45.000
		Preis [EUR]	75,-	75,-	75,-

Gewinkelte Abutments / 25 Grad

Titan Grade 5, unsteril, inkl. Schraube / Drehmoment: 25 Ncm

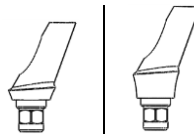
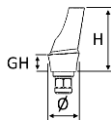

		Plattform	3,8
		H [mm]	7
		Ø [mm]	4,6
REF	Typ 1 25°	GH 1 mm	21.903.38.000
REF	Typ 1 25°	GH 2,5 mm	21.904.38.000
		Preis [EUR]	75,-

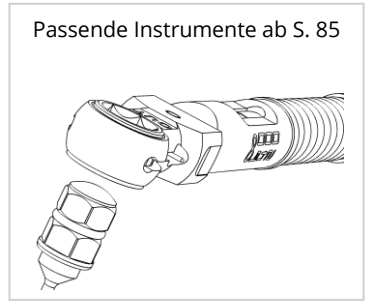

Titanbasen kurz, CAD/CAM

Titan Grade 5, unsteril, inkl. Schraube / Drehmoment: 25 Ncm / kompatibel mit: Exocad® & 3shape®

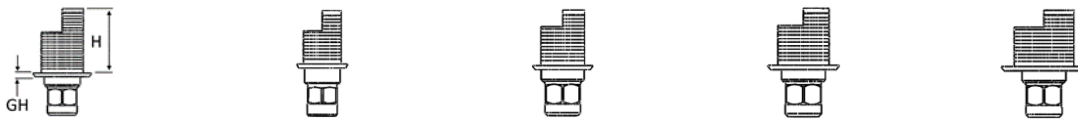

Plattform	3,4	3,8	4,5	5,5
GH [mm]	0,3	0,3	0,3	0,3
H [mm]	4	4	4	4
REF Typ 1	21.686.34.000	21.687.38.000	21.688.45.000	21.689.55.000
Preis [EUR]	45,-	45,-	45,-	45

Titanbasen lang, CAD/CAM

Titan Grade 5, unsteril, inkl. Schraube / Drehmoment: 25 Ncm / kompatibel mit: Exocad® & 3shape®

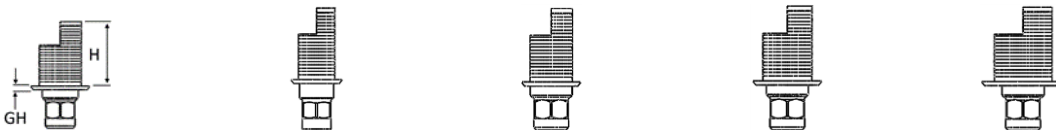

Plattform	3,4	3,8	4,5	5,5
H [mm]	0,3	0,3	0,3	0,3
H [mm]	5,5	5,5	5,5	5,5
REF	21.735.34.000	21.736.38.000	21.737.45.000	21.738.55.000
Preis [EUR]	45,-	45,-	45,-	45,-

[KLICK ZUM WEBSHOP](#)

Titanbasen nicht indexiert, CAD/CAM

Titan Grade 5, unsteril, inkl. Schraube / Drehmoment: 25 Ncm / ohne Rotationsschutz / kompatibel mit: Exocad® & 3shape®



Plattform	3,4	3,8	4,5	5,5
GH [mm]	0,3	0,3	0,3	0,3
H [mm]	4	4	4	4
REF	21.702.34.000	21.703.38.000	21.704.45.000	21.705.55.000
Preis [EUR]	40,-	40,-	40,-	40,-

Scanbodys

Titan Grade 4, unsteril, inkl. Schraube / Drehmoment: Handfest



Plattform	3,4	3,8	4,5	5,5
REF	21.710.34.000	21.711.38.000	21.712.45.000	21.713.55.000
Preis [EUR]	30,-	30,-	30,-	30,-

[KLICK ZUM WEBSHOP](#)

Pre-Mill Abutments

Titan Grade 5, unsteril, inkl. Schraube / Drehmoment: 25 Ncm, kompatibel zum Medentika®-Halter

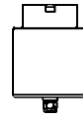

Plattform	3,4	3,8 / 4,5 / 5,5	3,8 / 4,5 / 5,5
Ø [mm]	11,5	11,5	15,8
REF	25.095.11.000	25.101.11.000	25.103.15.000
Preis [EUR]	37,-	37,-	37,-

Multi-Unit Abutments D3,4

Titan Grade 5, unsteril / Drehmoment: 25 Ncm



Plattform	3,4	3,4	3,4
GH [mm]	1	2	3
REF	21.714.34.010	21.715.34.020	21.716.34.030
Preis [EUR]	49,-	49,-	49,-

Passende Instrumente ab S. 85

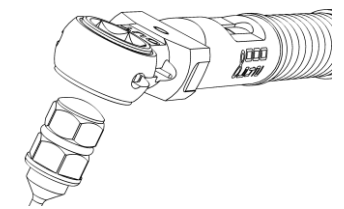

Multi-Unit Abutments D3,8

Titan Grade 5, unsteril / Drehmoment: 25 Ncm



 [Per Klick zum Webshop](#)

Plattform	3,8	3,8	3,8
GH [mm]	1	2	3
REF	21.718.38.010	21.719.38.020	21.720.38.030
Preis [EUR]	49,-	49,-	49,-

Multi-Unit Abutments D4,5

Titan Grade 5, unsteril / Drehmoment: 25 Ncm



Plattform	4,5	4,5	4,5
GH [mm]	1	2	3
REF	21.722.45.010	21.723.45.020	21.724.45.030
Preis [EUR]	49,-	49,-	49,-

Multi-Unit Zubehör

Titan Grade 5, unsteril, Anschluss: Hex 1,22

[KLICK ZUM WEBSHOP](#)



Titanbasis Multi-Unit, CAD/CAM **Titankappe Multi-Unit** **Verschlusskappe Multi-Unit** **Scanbody Multi-Unit** **Abformpfosten Multi-Unit (offene Abformung)** **Laboranalog Multi-Unit**

<i>Material</i>	Titan Grade 5	Titan Grade 5	Titan Grade 5	Titan Grade 4	Titan Grade 5	Titan Grade 5
<i>inkl. Schraube</i>	ja	ja	nein	ja	ja	nein
<i>Drehmoment</i>	15 Ncm	15 Ncm	Handfest	Handfest	Handfest	-
<i>REF</i>	21.733.00.000	21.732.00.000	21.730.45.037	21.734.00.000	23.076.00.000	24.048.45.100
<i>Preis [EUR]</i>	39,-	39,-	18,-	30,-	26,-	12,-

Abformpfosten kurz (offene Abformung)

Titan Grade 5, unsteril, inkl. Schraube, farbcodiert / Drehmoment: Handfest

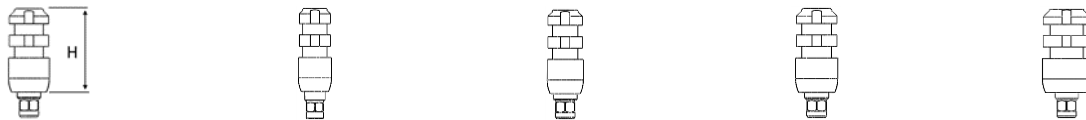

Plattform	3,4	3,8	4,5	5,5
<i>H [mm]</i>	11	11	11	11
<i>Farbcodierung</i>	keine	gelb	blau	rot
<i>REF</i>	23.082.34.000	23.083.38.000	23.084.45.000	23.085.55.000
<i>Preis [EUR]</i>	26,-	26,-	26,-	26,-

Abformpfosten lang (offene Abformung)

Titan Grade 5, unsteril, inkl. Schraube, farbcodiert / Drehmoment: Handfest

[KLICK ZUM WEBSHOP](#)

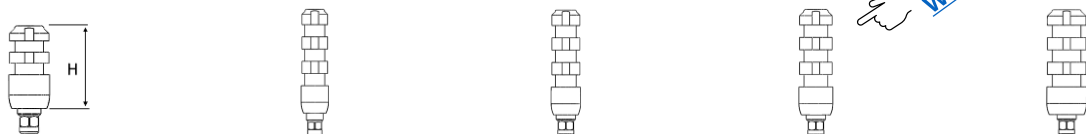

Plattform	3,4	3,8	4,5	5,5
<i>H [mm]</i>	17	17	17	17
<i>Farbcodierung</i>	keine	gelb	blau	rot
<i>REF</i>	23.091.34.000	23.092.38.000	23.093.45.000	23.094.55.000
<i>Preis [EUR]</i>	26,-	26,-	26,-	26,-

Heli-Loc (Deckprothesen Abutment)

Titan Grade 5 mit TiN-Beschichtung, unsteril, Drehmoment: 25 Ncm

[KLICK ZUM WEBSHOP](#)

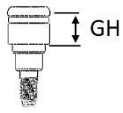

Plattform	3,4	3,4	3,4	3,4
GH [mm]	1	2	3	4
REF	26.219.34.010	26.220.34.020	26.221.34.030	26.222.34.040
Preis [EUR]	59,-	59,-	59,-	59,-

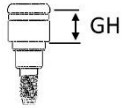

Plattform	3,8 / 4,5 / 5,5	3,8 / 4,5 / 5,5	3,8 / 4,5 / 5,5	3,8 / 4,5 / 5,5
GH [mm]	1	2	3	4
REF	26.224.38.010	26.225.38.020	26.226.38.030	26.227.38.040
Preis [EUR]	59,-	59,-	59,-	59,-

Zubehör zu den Heli-Loc Abutments auf Seite 81

Gingivaformer

Titan Grade 5, unsteril, inkl. Schraube, lasermarkiert / Drehmoment: Handfest

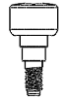
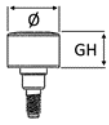

 [Per Klick zum Webshop](#)

Plattform	3,4	3,4	3,4
GH [mm]	3	4	5
Ø [mm]	4,5	4,5	4,5
REF	22.585.34.030	22.586.34.040	22.587.34.050
Preis [EUR]	18,-	18,-	18,-

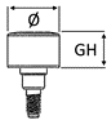

Plattform	3,8	3,8	3,8
GH [mm]	3	4	5
Ø [mm]	4,5	4,5	4,5
REF	22.589.38.030	22.590.38.040	22.591.38.050
Preis [EUR]	18,-	18,-	18,-

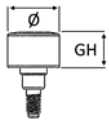

Plattform	4,5	4,5	4,5
GH [mm]	3	4	5
Ø [mm]	4,9	4,9	4,9
REF	22.593.45.030	22.594.45.040	22.595.45.050
Preis [EUR]	18,-	18,-	18,-

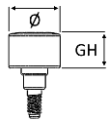

[KLICK ZUM WEBSHOP](#)

Plattform	5,5	5,5	5,5
GH [mm]	3	4	5
Ø [mm]	5,9	5,9	5,9
REF	22.597.55.030	22.598.55.040	22.599.55.050
Preis [EUR]	18,-	18,-	18,-

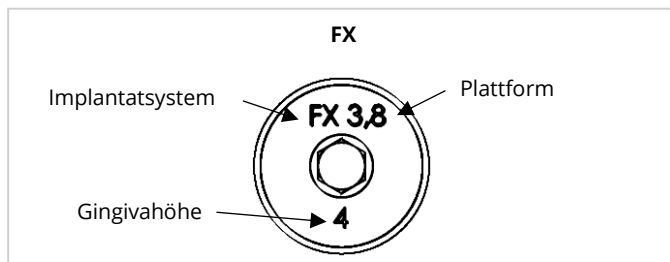

DS-AY Serie - kompatibel zu **Dentsply® - Ankylos® C/X**

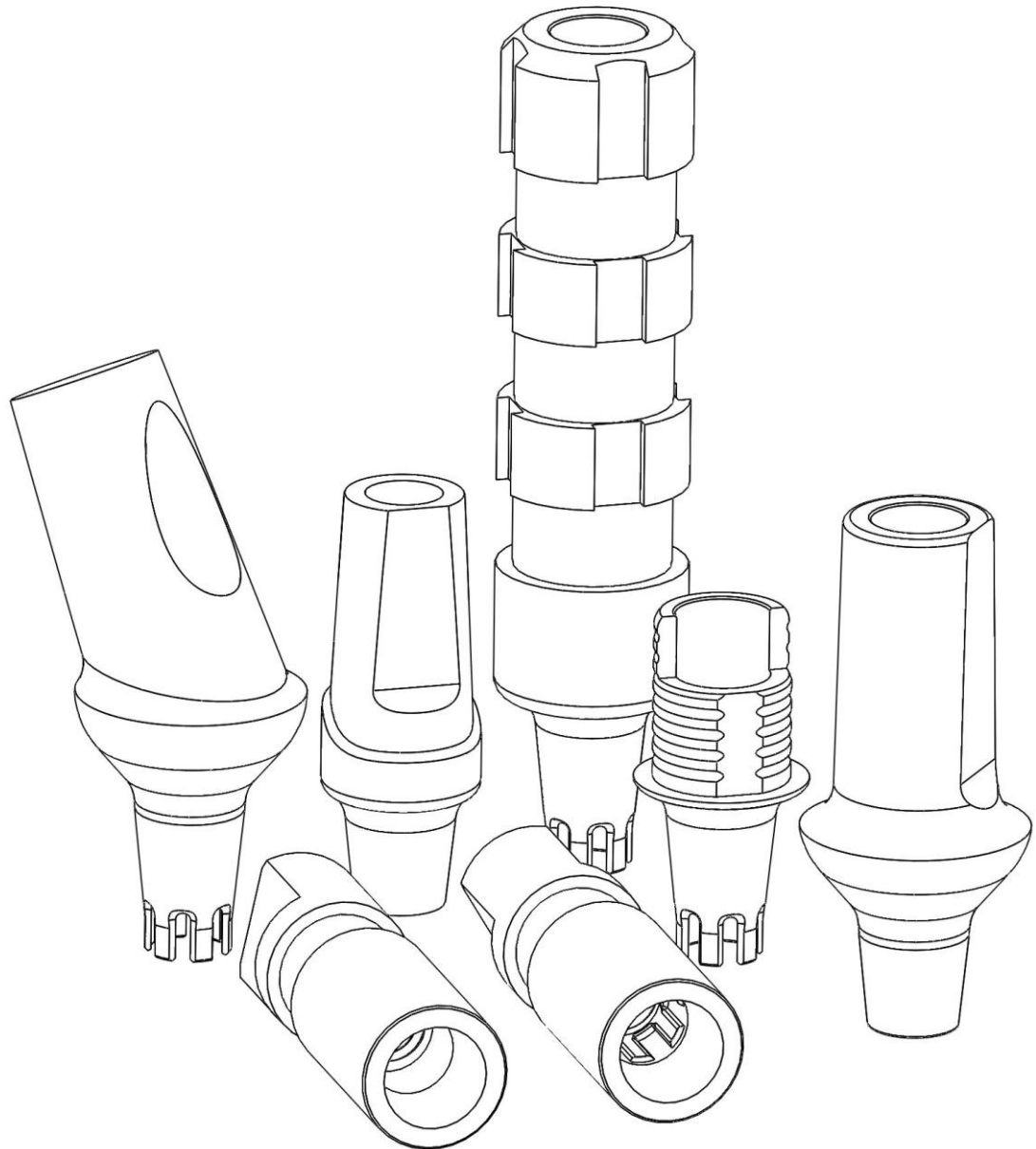

(X): mit Rotationssicherung / Index

(C): ohne Rotationssicherung / Index

Abutmentschrauben

Titan Grade 5, unsteril, Anschluss: Hex 1,01

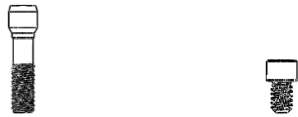

Plattform	A / B / C / D	Multi-Unit
Größe	M 1,8	M 1,4
REF	22.679.18.095	22.748.21.035
Preis [EUR]	10,-	10,-

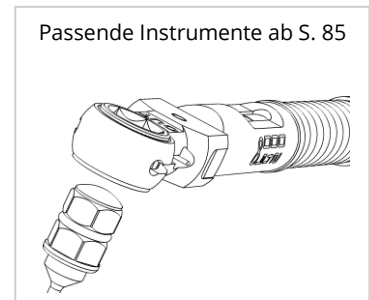

Laborschrauben

Titan Grade 5, unsteril, Anschluss: Hex 1,01, farbcodiert gelb/ Drehmoment: Handfest



Plattform	A / B / C / D	Multi-Unit
Größe	M 1,8	M 1,4
REF	24.093.18.095	24.110.21.035
Preis [EUR]	6,-	6,-
ab 5 Stk.	4,-	4,-
ab 10 Stk.	3,50	3,50

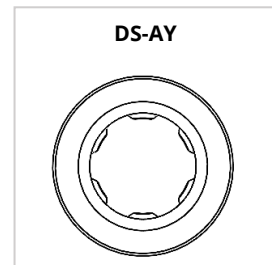

Laboranaloge

Titan Grade 5, unsteril, farbcodiert, für 3D Druck geeignet

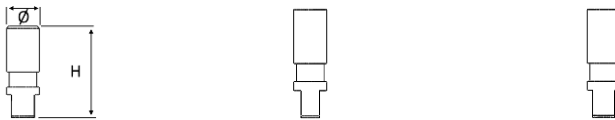

[Per Klick zum Webshop](#)

Plattform	A / B / C / D (C)	A / B / C / D (X)
H [mm]	12	12
Ø [mm]	3,5	3,5
Farbcodierung	keine	rot
REF	24.079.00.100	24.081.00.120
Preis [EUR]	12,-	12,-
ab 10 Stk.	9,-	9,-
ab 30 Stk.	8,-	8,-

Gerade Abutments

Titan Grade 5, unsteril, inkl. Schraube / Drehmoment: 25 Ncm

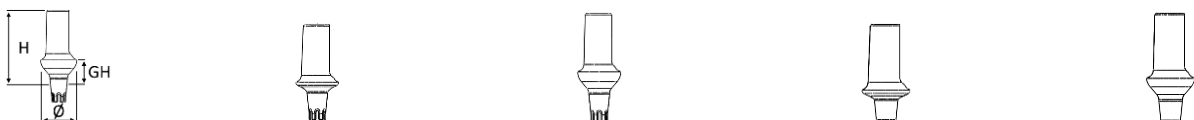

Plattform	A / B / C / D (X)	A / B / C / D (X)	A / B / C / D (C)	A / B / C / D (C)
GH [mm]	1,5	3,0	1,5	3,0
H [mm]	9	10,5	9	10,5
Ø [mm]	5,4	5,4	5,4	5,4
REF	22.694.54.001	22.695.54.001	22.692.54.000	22.693.54.000
Preis [EUR]	60,-	60,-	60,-	60,-

Gewinkelte Abutments (X)

Titan Grade 5, unsteril, inkl. Schraube / Drehmoment: 25 Ncm

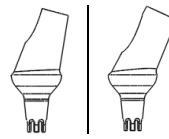
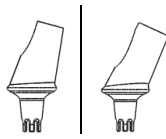
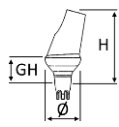

 [Per Klick zum Webshop](#)

Plattform	A / B / C / D	A / B / C / D
GH [mm]	1,5	3
H [mm]	7	7
Ø [mm]	5,4	5,4
REF 15°	22.708.54.001	22.710.54.001
REF 25°	22.709.54.001	22.711.54.001
Preis [EUR]	75,-	75,-

Nicht indexierte Abutments (C)

Titan Grade 5, unsteril, inkl. Schraube / Drehmoment: 25 Ncm

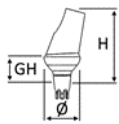

Plattform	A / B / C / D	A / B / C / D
GH [mm]	1,5	3
H [mm]	7	7
Ø [mm]	5,4	5,4
REF 15°	22.704.54.000	22.706.54.000
Preis [EUR]	75,-	75,-

Titanbasen, CAD/CAM

Titan Grade 5, unsteril, inkl. Schraube / Drehmoment: 25 Ncm / kompatibel mit: Exocad® & 3shape®

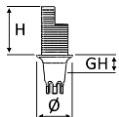

 [KLICK ZUM WEBSHOP](#)

Plattform	A / B / C / D (X)	A / B / C / D (X)	A / B / C / D (C)
GH [mm]	1,0	1,0	1,0
H [mm]	4	5,5	4
Ø [mm]	4,1	4,1	4,1
REF	22.739.41.001	22.740.41.001	22.741.41.000
Preis [EUR]	45,-	45,-	40,-

Passende Instrumente ab S. 85

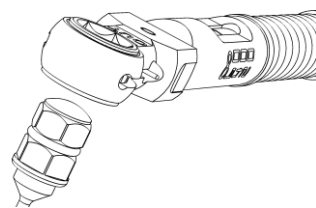

Scanbodys

Titan Grade 4, unsteril, inkl. Schraube / Drehmoment: Handfest

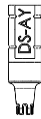

Passende Instrumente ab S. 85

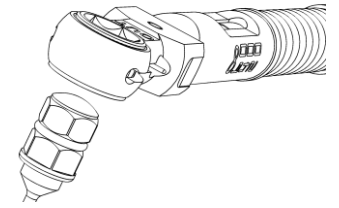

Plattform	A / B / C / D
REF	22.743.41.001
Preis [EUR]	30,-

Pre-Mill Abutments

Titan Grade 5, unsteril, inkl. Schraube / Drehmoment: 25 Ncm, kompatibel zum Medentika®-Halter

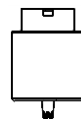
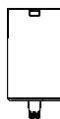

Plattform	11,5	15,8
Ø [mm]	11,5	15,8
REF	25.264.11.001	25.266.15.001
Preis [EUR]	37,-	37,-

Multi-Unit Abutments

Titan Grade 5, unsteril / Drehmoment: 25 Ncm

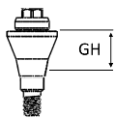

[Per Klick zum Webshop](#)

Plattform	A / B / C / D	A / B / C / D	A / B / C / D
GH [mm]	1,5	3,0	4,5
REF	22.744.37.015	22.745.37.030	22.746.37.045
Preis [EUR]	49,-	49,-	49,-

Multi-Unit Zubehör

Titan Grade 5, unsteril, Anschluss: Hex 1,01

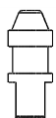

**Titanbasis
Multi-Unit,
CAD/CAM**

**Titankappe
Multi-Unit**

**Verschlusskappe
Multi-Unit**

**Scanbody
Multi-Unit**

**Abformpfosten
Multi-Unit
(offene
Abformung)**

**Laboranalog
Multi-Unit**

	Titanbasis Multi-Unit, CAD/CAM	Titankappe Multi-Unit	Verschlusskappe Multi-Unit	Scanbody Multi-Unit	Abformpfosten Multi-Unit (offene Abformung)	Laboranalog Multi-Unit
Material	Titan Grade 5	Titan Grade 5	Titan Grade 5	Titan Grade 4	Titan Grade 5	Titan Grade 5
inkl. Schraube	ja	ja	nein	ja	ja	nein
Drehmoment	15 Ncm	15 Ncm	Handfest	Handfest	Handfest	-
REF	22.750.42.000	22.676.30.000	22.747.45.037	22.751.00.000	23.180.00.000	24.048.45.100
Preis [EUR]	39,-	39,-	18,-	30,-	26,-	12,-

DS-AY Serie - kompatibel zu Dentsply® - Ankylos® C/X

Abformpfosten (offene Abformung)

Titan Grade 5, unsteril, inkl. Schraube / Drehmoment: Handfest

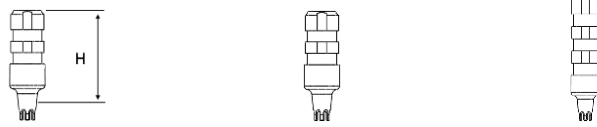

Plattform	A / B / C / D	A / B / C / D
H [mm]	11	17
Farbcodierung	keine	keine
REF	23.183.45.001	23.186.45.001
Preis [EUR]	26,-	26,-

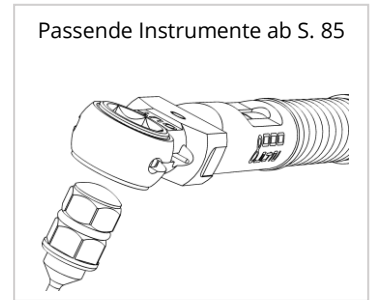

Heli-Loc (Deckprothesen Abutment)

Titan Grade 5 mit TiN-Beschichtung, unsteril, Drehmoment: 25 Ncm



Plattform	A - D	A - D	A - D	A - D
GH [mm]	1	2	3	4
REF	26.244.37.010	26.245.37.020	26.246.37.030	26.247.37.040
Preis [EUR]	59,-	59,-	59,-	59,-

Zubehör zu den Heli-Loc Abutments auf Seite 81

Gingivaformer

Titan Grade 5, unsteril, lasermarkiert / Drehmoment: Handfest

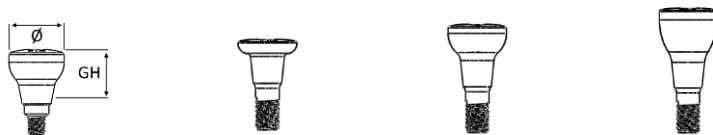

Plattform	A / B / C / D	A / B / C / D	A / B / C / D
GH [mm]	1,5	3	4,5
Ø [mm]	4,5	4,5	4,5
REF	22.752.00.015	22.753.00.030	22.754.00.045
Preis [EUR]	18,-	18,-	18,-

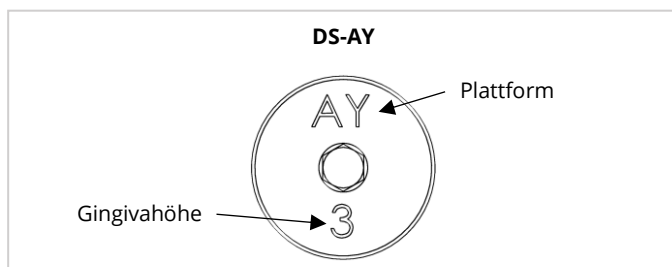

ZMB Serie - kompatibel zu Zimmer Dental® - TSRV / MIS® - Seven® / Biohorizons® - Internal Hex

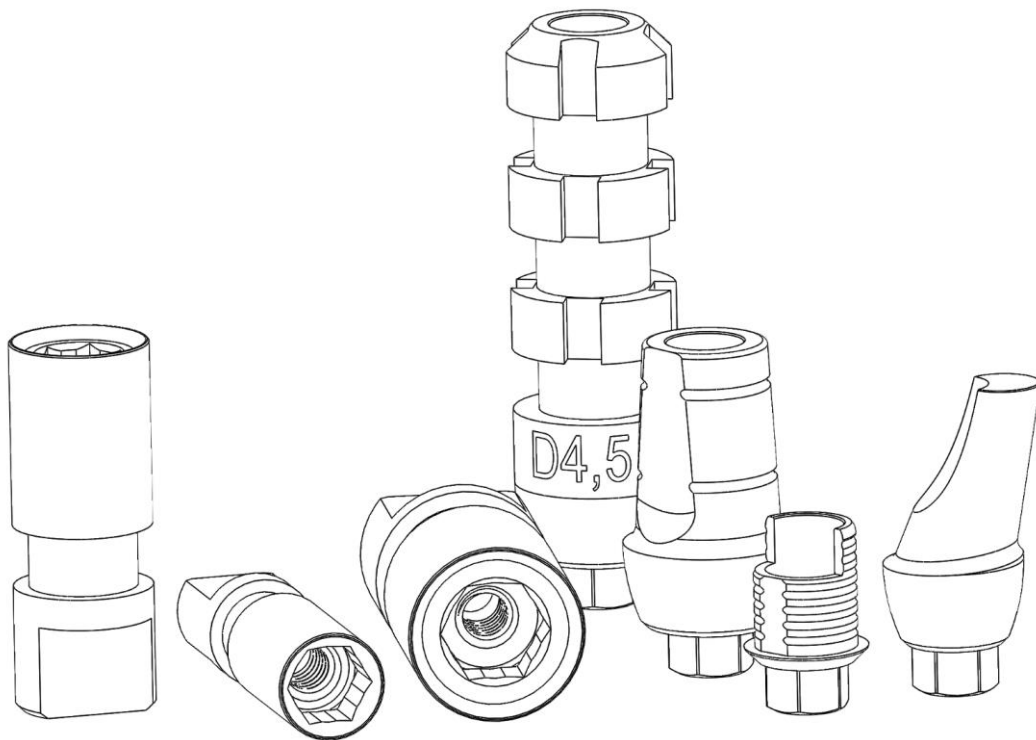

Zimmer Dental®

Implantatdurchmesser	3,7 & 4,1	4,7	6,0
Plattform	3,5	4,5	5,7
Farbe der prot. Plattform	grün	lila	gelb

MIS®

Implantatdurchmesser	3,75 SP & 4,20 SP	5 WP & 6 WP
Plattform	3,5	4,5
Farbe der prot. Plattform	lila	grün

SP = Standardplattform / WP = Weite Plattform

Biohorizons®

Implantatdurchmesser	3,0* & 3,8	4,6	5,8
Plattform	3,5	4,5	5,7
Farbe der prot. Plattform	gelb	grün	blau

*) Nur für Tapered Tissue Level Implantate

Abutmentschrauben

Titan Grade 5, unsteril, Anschluss: Hex 1,26



Plattform	3,5 / 4,5 / 5,7	Multi-Unit
Größe	M 1,8	M 1,4
REF	21.000.00.072	21.094.21.035
Preis [EUR]	10,-	10,-

Laborschrauben

Titan Grade 5, unsteril, Anschluss: Hex 1,26, farbcodiert gelb/ Drehmoment: Handfest



Plattform	3,5 / 4,5 / 5,7	Multi-Unit
Größe	M 1,8	M 1,4
REF	24.013.00.072	24.107.21.035
Preis [EUR]	6,-	6,-
ab 5 Stk.	4,-	4,-
ab 10 Stk.	3,50	3,50

Passende Instrumente ab S. 85

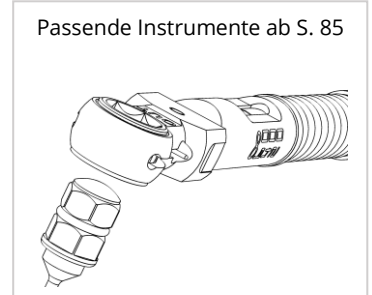

Laboranaloge

Titan Grade 5, unsteril, farbcodiert, für 3D Druck geeignet

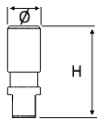

[KLICK ZUM WEBSHOP](#)

Plattform	3,5	4,5	5,7
H [mm]	12	12	12
Ø [mm]	3,5	4,5	5,7
Farbcodierung	grün	lila	gelb
REF	24.010.35.010	24.011.45.010	24.012.57.010
Preis [EUR]	12,-	12,-	12,-
ab 10 Stk.	9,-	9,-	9,-
ab 30 Stk.	8,-	8,-	8,-

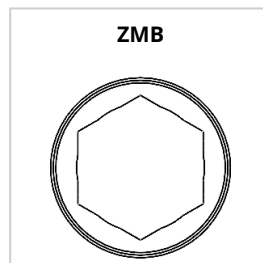

Gerade Abutments

Titan Grade 5, unsteril, inkl. Schraube / Drehmoment: 30 Ncm

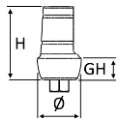

Plattform	3,5	3,5	4,5	4,5	5,7	5,7
GH [mm]	1	2,5	1	2,5	1	2,5
H [mm]	7,5	9,1	7,5	9,1	7,5	9,1
Ø [mm]	4,3	4,5	5,2	5,5	6	6,5
REF	21.017.35.000	21.020.35.000	21.018.45.000	21.021.45.000	21.019.57.000	21.022.57.000
Preis [EUR]	60,-	60,-	60,-	60,-	60,-	60,-

Gewinkelte Abutments / 16 Grad

Titan Grade 5, unsteril, inkl. Schraube / Drehmoment: 30 Ncm

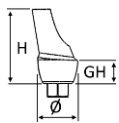

[KLICK ZUM WEBSHOP](#)

Plattform	3,5	3,5	4,5	4,5
GH [mm]	1	2,5	1	2,5
H [mm]	6,8	8,3	6,8	8,3
Ø [mm]	4,3	4,5	5,2	5,5
REF Typ 1 (16°)	21.029.35.000	21.041.35.000	21.030.45.000	21.042.45.000
Preis [EUR]	75,-	75,-	75,-	75,-

Gewinkelte Abutments / 25 Grad

Titan Grade 5, unsteril, inkl. Schraube / Drehmoment: 30 Ncm

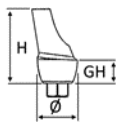

Plattform	3,5	3,5	4,5	4,5
GH [mm]	1	2,5	1	2,5
H [mm]	6,8	8,3	6,8	8,3
Ø [mm]	4,3	4,5	5,2	5,5
REF Typ 1 (25°)	21.194.35.000	21.206.35.000	21.195.45.000	21.207.45.000
Preis [EUR]	75,-	75,-	75,-	75,-

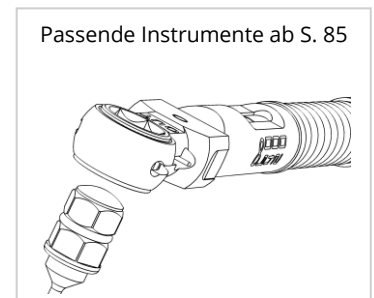

Titanbasen kurz, CAD/CAM

Titan Grade 5, unsteril, inkl. Schraube / Drehmoment: 30 Ncm / kompatibel mit: Exocad® & 3shape®

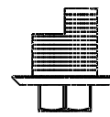
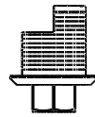
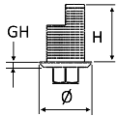

	Plattform	3,5	4,5	5,7
	<i>GH [mm]</i>	0,4	0,4	0,4
	<i>H [mm]</i>	4	4	4
	<i>Ø [mm]</i>	4	5	6,1
<i>REF</i>	Typ 1	21.056.35.000	21.057.45.000	21.058.57.000
	<i>Preis [EUR]</i>	45,-	45,-	45,-

Titanbasen lang, CAD/CAM

Titan Grade 5, unsteril, inkl. Schraube / Drehmoment: 30 Ncm / kompatibel mit: Exocad® & 3shape®

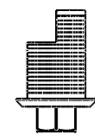
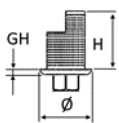

	Plattform	3,5	4,5	5,7
	<i>GH [mm]</i>	0,4	0,4	0,4
	<i>H [mm]</i>	5,5	5,5	5,5
	<i>Ø [mm]</i>	4	5	6,1
<i>REF</i>	Typ 1	21.062.35.000	21.063.45.000	21.064.57.000
	<i>Preis [EUR]</i>	45,-	45,-	45,-

Titanbasen nicht indiziert, CAD/CAM

Titan Grade 5, unsteril, inkl. Schraube / Drehmoment: 30 Ncm / kompatibel mit: Exocad® & 3shape®

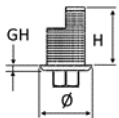

[KLICK ZUM WEBSHOP](#)

	Plattform	3,5	4,5	5,7
	<i>GH [mm]</i>	0,4	0,4	0,4
	<i>H [mm]</i>	3,5	3,5	3,5
	<i>Ø [mm]</i>	4	5	6,1
<i>REF</i>		21.068.35.000	21.069.45.000	21.070.57.000
	<i>Preis [EUR]</i>	40,-	40,-	40,-

Passende Instrumente ab S. 85

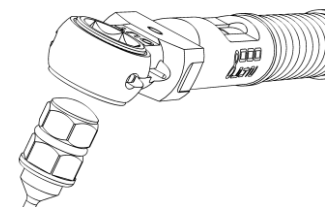

Scanbodys

Titan Grade 4, unsteril, inkl. Schraube / Drehmoment: Handfest



Plattform	3,5	4,5	5,7
REF	21.333.35.127	21.334.45.127	21.335.57.127
Preis [EUR]	30,-	30,-	30,-

Pre-Mill Abutments

Titan Grade 5, unsteril, inkl. Schraube / Drehmoment: 30 Ncm, kompatibel zum Medentika®-Halter

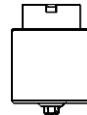
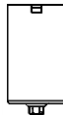

Plattform	3,5	4,5
∅ [mm]	11,5	15,8
REF	25.005.11.000	25.015.15.000
Preis [EUR]	37,-	37,-

Multi-Unit Abutments D3,5

Titan Grade 5, unsteril / Drehmoment: 30 Ncm

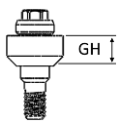

 [Per Klick zum Webshop](#)

Plattform	3,5	3,5	3,5	3,5
GH [mm]	1,5	2,5	3,5	4,5
REF	21.075.35.073	21.076.35.083	21.077.35.093	21.078.35.102
Preis [EUR]	49,-	49,-	49,-	49,-

Multi-Unit Abutments D4,5

Titan Grade 5, unsteril / Drehmoment: 30 Ncm

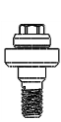
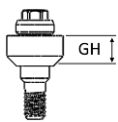

Passende Instrumente ab S. 85

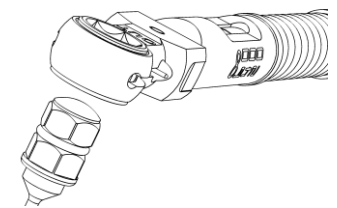

Plattform	4,5	4,5	4,5
GH [mm]	1,5	2,5	3,5
REF	21.080.45.072	21.081.45.082	21.082.45.092
Preis [EUR]	49,-	49,-	49,-

Multi-Unit Zubehör

Titan Grade 5, unsteril, Anschluss: Hex 1,26

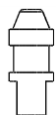

	Titanbasis Multi-Unit, CAD/CAM	Titankappe Multi-Unit	Verschlusskappe Multi-Unit	Scanbody Multi-Unit	Abformpfosten Multi-Unit (offene Abformung)	Laboranalog Multi-Unit
Material	Titan Grade 5	Titan Grade 5	Titan Grade 5	Titan Grade 4	Titan Grade 5	Titan Grade 5
inkl. Schraube	ja	ja	nein	ja	ja	nein
Drehmoment	15 Ncm	15 Ncm	Handfest	Handfest	Handfest	-
REF	21.098.42.000	21.096.30.000	21.093.45.037	21.182.00.000	23.019.00.000	24.048.45.100
Preis [EUR]	39,-	39,-	18,-	30,-	26,-	12,-

Abformpfosten kurz (offene Abformung)

Titan Grade 5, unsteril, inkl. Schraube, lasermarkiert / Drehmoment: Handfest

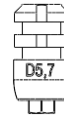
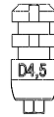
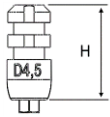

Plattform	3,5	4,5	5,7
H [mm]	11,5	11,5	11,5
Farbcodierung	keine	keine	keine
REF	23.007.35.000	23.008.45.000	23.009.57.000
Preis [EUR]	26,-	26,-	26,-

Abformpfosten lang (offene Abformung)

Titan Grade 5, unsteril, inkl. Schraube, lasermarkiert / Drehmoment: Handfest

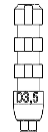
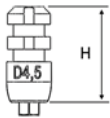

[KLICK ZUM WEBSHOP](#)

Plattform	3,5	4,5	5,7
H [mm]	17,5	17,5	17,5
Farbcodierung	keine	keine	keine
REF	23.014.35.000	23.015.45.000	23.016.57.000
Preis [EUR]	26,-	26,-	26,-

Heli-Loc (Deckprothesen Abutment)

Titan Grade 5 mit TiN-Beschichtung, unsteril, Drehmoment: 30 Ncm

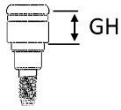

[KLICK ZUM WEBSHOP](#)

Plattform	3,5	3,5	3,5	3,5
GH [mm]	1	2	3	4
REF	26.251.35.010	26.252.35.020	26.253.35.030	26.254.35.040
Preis [EUR]	59,-	59,-	59,-	59,-

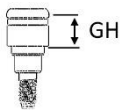

Plattform	4,5	4,5	4,5	4,5
GH [mm]	1	2	3	4
REF	26.258.45.010	26.259.45.020	26.260.45.030	26.261.45.040
Preis [EUR]	59,-	59,-	59,-	59,-

Zubehör zu den Heli-Loc Abutments auf Seite 81

Gingivaformer

Titan Grade 5, unsteril, inkl. Schraube, lasermarkiert / Drehmoment: Handfest

[KLICK ZUM WEBSHOP](#)

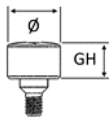

Plattform	3,5	3,5	3,5
GH [mm]	3	4	5
Ø [mm]	4,5	4,5	4,5
REF	21.260.35.030	21.261.35.040	21.262.35.050
Preis [EUR]	18,-	18,-	18,-

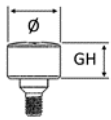

Plattform	4,5	4,5	4,5
GH [mm]	3	4	5
Ø [mm]	4,9	4,9	4,9
REF	21.263.45.030	21.264.45.040	21.265.45.050
Preis [EUR]	18,-	18,-	18,-

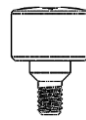
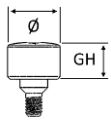

Plattform	5,7	5,7	5,7
GH [mm]	3	4	5
Ø [mm]	5,9	5,9	5,9
REF	21.266.57.030	21.267.57.040	21.268.57.050
Preis [EUR]	18,-	18,-	18,-

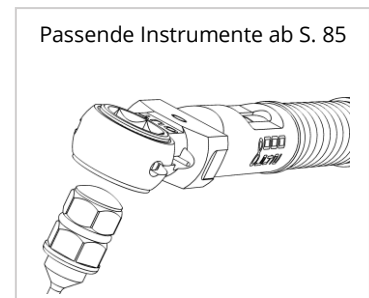
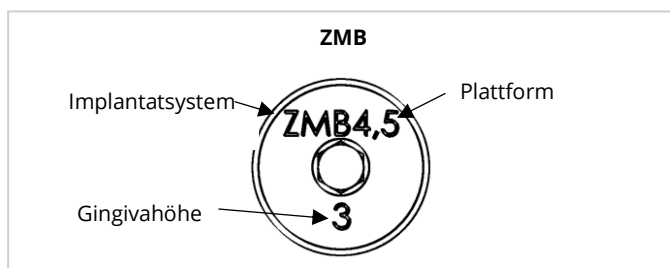

NB-AV Serie - kompatibel zu: Nobel Biocare® - NobelActive® /NobelParallel Conical Connection / NobelReplace® Conical Connection

NB-AV Serie - kompatibel zu **Nobel Biocare® - NobelActive®** /**NobelParallel Conical Connection** / **NobelReplace® Conical Connection**

 **heliocos**
compatible to
Nobel Biocare®

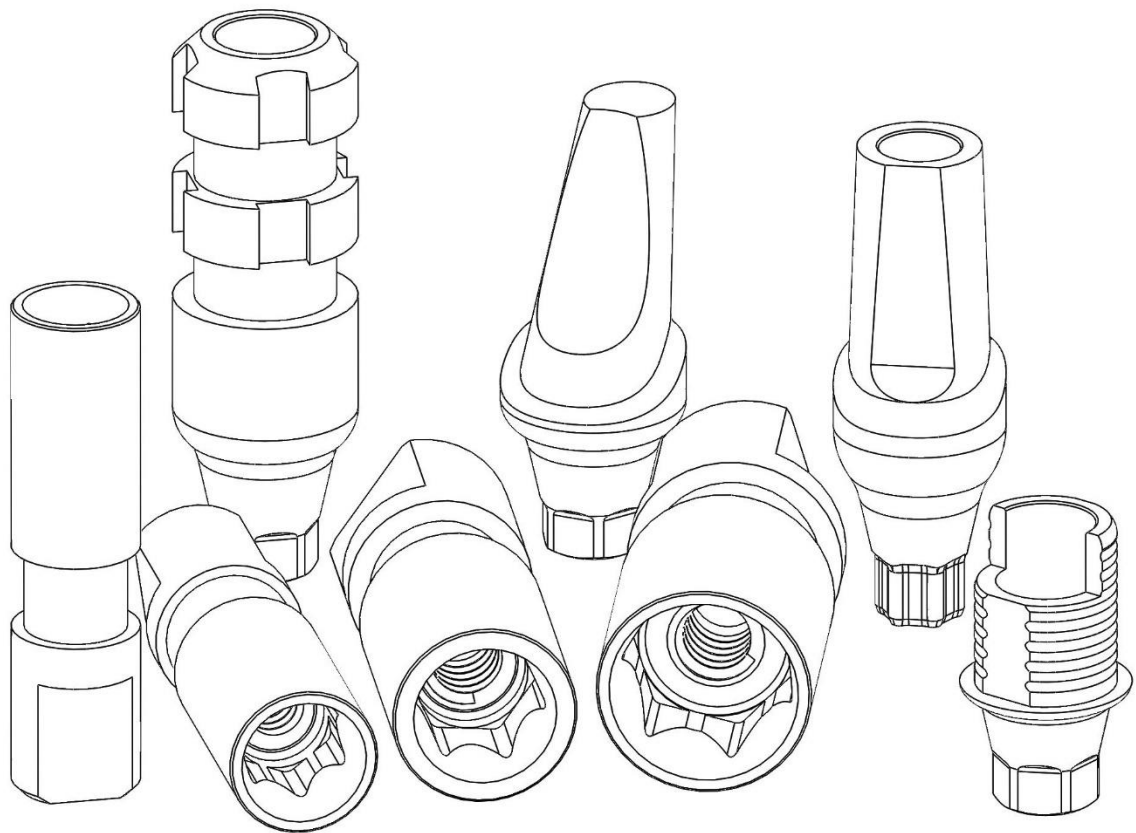

NB-AV Serie - kompatibel zu: Nobel Biocare® - NobelActive® /NobelParallel Conical Connection / NobelReplace® Conical Connection

Abutmentschrauben

Titan Grade 5, unsteril, Anschluss: UniGrip

[KLICK ZUM WEBSHOP](#)



Plattform	3,0	NP	RP / WP	Multi-Unit
Größe	M 1,4	M 1,6	M 2,0	M 1,4
REF	21.695.14.067	21.696.16.077	21.697.20.080	21.860.21.035
Preis [EUR]	10,-	10,-	10,-	10,-

Laborschrauben

Titan Grade 5, unsteril, Anschluss: UniGrip, farbcodiert gelb/ Drehmoment: Handfest



Plattform	3,0	NP	RP / WP	Multi-Unit
Größe	M 1,4	M 1,6	M 2,0	M 1,4
REF	24.100.14.067	24.101.16.077	24.102.20.080	24.111.21.035
Preis [EUR]	6,-	6,-	6,-	6,-
ab 5 Stk.	4,-	4,-	4,-	4,-
ab 10 Stk.	3,50	3,50	3,50	3,50

Laboranaloge

Titan Grade 5, unsteril, farbcodiert, für 3D Druck geeignet

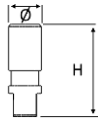

Plattform	3,0	NP	RP	WP
H [mm]	12	12	12	12
Ø [mm]	3,0	3,5	4,3	5,0
Farbcodierung	keine	lila	gelb	blau
REF	24.076.30.100	24.077.35.100	24.078.00.100	24.088.50.120
Preis [EUR]	12,-	12,-	12,-	12,-
ab 10 Stk.	9,-	9,-	9,-	9,-
ab 30 Stk.	8,-	8,-	8,-	8,-

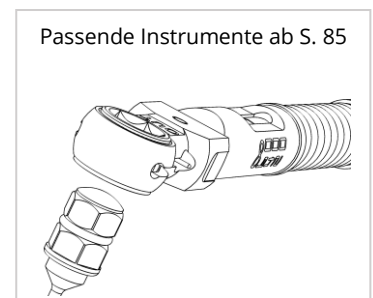
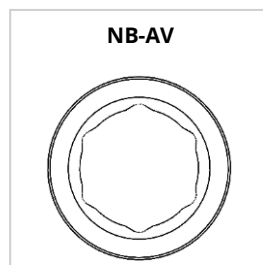

NB-AV Serie - kompatibel zu: Nobel Biocare® - NobelActive® /NobelParallel Conical Connection / NobelReplace® Conical Connection

Gerade Abutments

Titan Grade 5, unsteril, inkl. Schraube / Drehmoment 3,0: 15 Ncm / NP, RP, WP: 35 Ncm

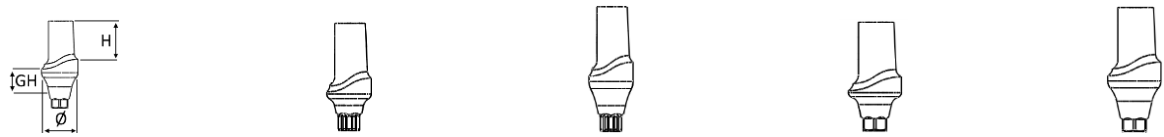

Plattform		3,0	NP	RP	WP
	<i>H [mm]</i>	5	5	5	5
	<i>Ø [mm]</i>	4	4,5	4,9	5,9
REF	GH 1,5 mm	21.769.30.000	21.771.35.000	21.773.00.000	21.944.55.000
REF	GH 3 mm	21.770.30.000	21.772.35.000	21.774.00.000	21.945.55.000
	<i>Preis [EUR]</i>	60,-	60,-	60,-	60,-

Gewinkelte Abutments

Titan Grade 5, unsteril, inkl. Schraube / Drehmoment: 35 Ncm



Plattform		NP	NP	RP	RP
	<i>GH [mm]</i>	1,5	3	1,5	3
	<i>H [mm]</i>	5	5	5	5
	<i>Ø [mm]</i>	4,3	4,3	5	5
REF	Typ 1 18°	21.783.35.000	21.784.35.000	21.785.00.000	21.786.00.000
REF	Typ 1 25°	21.872.35.000	21.873.35.000	21.874.00.000	21.875.00.000
	<i>Preis [EUR]</i>	75,-	75,-	75,-	75,-

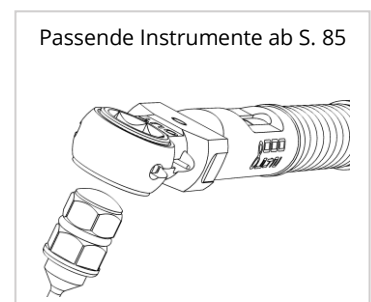
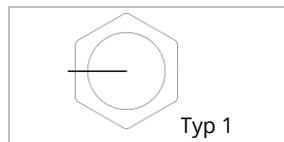

Titanbasen kurz, CAD/CAM

Titan Grade 5, unsteril, inkl. Schraube / kompatibel mit: Exocad® & 3shape®

3,0: Drehmoment: 15 Ncm

3,5/4,0 und 4,5/5,0: Drehmoment: 35 Ncm

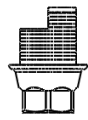
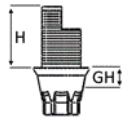

Plattform	3,0	NP	RP	WP
GH [mm]	0,65	0,65	0,65	0,65
H [mm]	4	4	4	4
REF Typ 1	21.820.30.000	21.821.35.000	21.822.00.000	21.961.55.000
Preis [EUR]	45,-	45,-	45,-	45,-

Titanbasen lang, CAD/CAM

Titan Grade 5, unsteril, inkl. Schraube / kompatibel mit: Exocad® & 3shape®

3,0: Drehmoment: 15 Ncm

3,5/4,0 und 4,5/5,0: Drehmoment: 35 Ncm

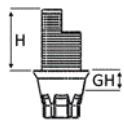

Plattform	3,0	NP	RP	WP
GH [mm]	0,65	0,65	0,65	0,65
H [mm]	5,5	5,5	5,5	5,5
REF Typ 1	21.826.30.000	21.827.35.000	21.828.00.000	21.963.55.000
Preis [EUR]	45,-	45,-	45,-	45,-

Titanbasen nicht indiziert, CAD/CAM

Titan Grade 5, unsteril, inkl. Schraube / Drehmoment: 35 Ncm / kompatibel mit: Exocad® & 3shape®

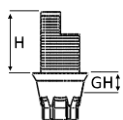

Plattform	NP	RP	WP
GH [mm]	0,65	0,65	0,65
H [mm]	4	4	4
REF	21.843.35.000	21.844.00.000	21.969.55.000
Preis [EUR]	40,-	40,-	40,-

NB-AV Serie - kompatibel zu: Nobel Biocare® - NobelActive® /NobelParallel Conical Connection / NobelReplace® Conical Connection

Scanbodys

Titan Grade 4, unsteril, inkl. Schraube / Drehmoment: Handfest



Plattform	3,0	NP	RP	WP
REF	21.848.30.000	21.849.35.000	21.850.00.000	21.971.55.000
Preis [EUR]	30,-	30,-	30,-	30,-

Pre-Mill Abutments

Titan Grade 5, unsteril, inkl. Schraube / Drehmoment 3,0: 15 Ncm / NP, RP, WP: 35 Ncm, kompatibel zum Medentika®-Halter

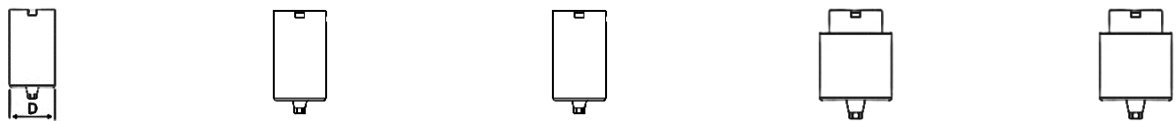

Plattform	3,0	NP	RP	WP
Ø [mm]	11,5	11,5	15,8	15,8
REF	25.107.11.000	25.113.11.000	25.123.15.000	25.131.15.000
Preis [EUR]	37,-	37,-	37,-	37,-

Multi-Unit Abutments NP

Titan Grade 5, unsteril / Drehmoment: 35 Ncm



Plattform	NP	NP	NP
GH [mm]	1,5	2,5	3,5
REF	21.851.35.015	21.852.35.025	21.853.35.035
Preis [EUR]	49,-	49,-	49,-

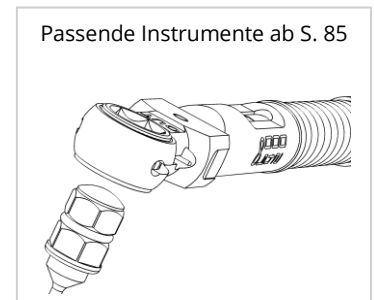

Multi-Unit Abutments RP

Titan Grade 5, unsteril / Drehmoment: 35 Ncm



[Per Klick zum Webshop](#)

Plattform	RP	RP	RP	RP
GH [mm]	1,5	2,5	3,5	4,5
REF	21.855.00.015	21.856.00.025	21.857.00.035	21.858.00.045
Preis [EUR]	49,-	49,-	49,-	49,-

Multi-Unit Zubehör

Titan Grade 5, unsteril, Anschluss: UniGrip



**Titanbasis
Multi-Unit,
CAD/CAM**

**Titankappe
Multi-Unit**

**Verschlusskappe
Multi-Unit**

**Scanbody
Multi-Unit**

**Abformpfosten
Multi-Unit
(offene
Abformung)**

**Laboranalog
Multi-Unit**

<i>Material</i>	Titan Grade 5	Titan Grade 5	Titan Grade 5	Titan Grade 4	Titan Grade 5	Titan Grade 5
<i>inkl. Schraube</i>	ja	ja	nein	ja	ja	nein
<i>Drehmoment</i>	15 Ncm	15 Ncm	Handfest	Handfest	Handfest	-
<i>REF</i>	21.862.00.000	21.861.00.000	21.859.45.037	21.863.00.000	23.096.00.000	24.048.45.100
<i>Preis [EUR]</i>	39,-	39,-	18,-	30,-	26,-	12,-

Abformpfosten kurz (offene Abformung)

Titan Grade 5, unsteril, inkl. Schraube, farbcodiert / Drehmoment: Handfest

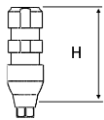

[KLICK ZUM
WEBSHOP](#)

Plattform	3,0	NP	RP	WP
<i>H [mm]</i>	11	11	11	11
<i>Farbcodierung</i>	keine	lila	gelb	blau
<i>REF</i>	23.103.30.000	23.104.35.000	23.105.00.000	23.138.55.000
<i>Preis [EUR]</i>	26,-	26,-	26,-	26,-

Abformpfosten lang (offene Abformung)

Titan Grade 5, unsteril, inkl. Schraube, farbcodiert / Drehmoment: Handfest

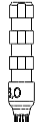
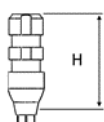

Plattform	3,0	NP	RP	WP
<i>H [mm]</i>	17	17	17	17
<i>Farbcodierung</i>	keine	lila	gelb	blau
<i>REF</i>	23.112.30.000	23.113.35.000	23.114.00.000	23.140.55.000
<i>Preis [EUR]</i>	26,-	26,-	26,-	26,-

NB-AV Serie - kompatibel zu: Nobel Biocare® - NobelActive® /NobelParallel Conical Connection / NobelReplace® Conical Connection

[KLICK ZUM WEBSHOP](#)

Heli-Loc (Deckprothesen Abutment)

Titan Grade 5 mit TiN-Beschichtung, unsteril, Drehmoment: 35 Ncm

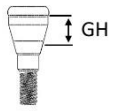

Plattform	NP	NP	NP	NP
GH [mm]	1	2	3	4
REF	26.184.35.010	26.185.35.020	26.186.35.030	26.187.35.040
Preis [EUR]	59,-	59,-	59,-	59,-

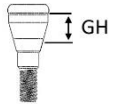

Plattform	RP	RP	RP	RP
GH [mm]	1	2	3	4
REF	26.183.43.010	26.195.43.020	26.196.43.030	26.197.43.040
Preis [EUR]	59,-	59,-	59,-	59,-

Zubehör zu den Heli-Loc Abutments auf Seite 81

NB-AV Serie - kompatibel zu: Nobel Biocare® - NobelActive® /NobelParallel Conical Connection / NobelReplace® Conical Connection

Gingivaformer

Titan Grade 5, unsteril, inkl. Schraube, lasermarkiert / Drehmoment: Handfest

[KLICK ZUM WEBSHOP](#)

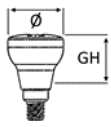

Plattform	3,0	3,0	3,0	NP	NP	NP
GH [mm]	3	4	5	3	4	5
Ø [mm]	3,8	3,8	3,8	4,5	4,5	4,5
REF	21.269.30.030	21.270.30.040	21.271.30.050	21.272.35.030	21.273.35.040	21.274.35.050
Preis [EUR]	18,-	18,-	18,-	18,-	18,-	18,-

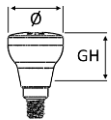

Plattform	RP	RP	RP	WP	WP	WP
GH [mm]	3	4	5	3	4	5
Ø [mm]	4,9	4,9	4,9	5,5	5,5	5,5
REF	21.275.43.030	21.276.43.040	21.277.43.050	21.278.50.030	21.279.50.040	21.280.50.050
Preis [EUR]	18,-	18,-	18,-	18,-	18,-	18,-

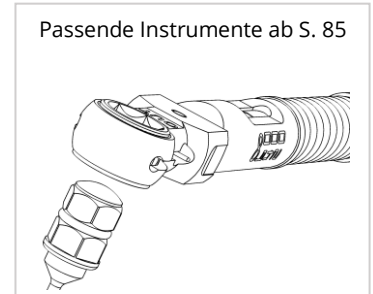
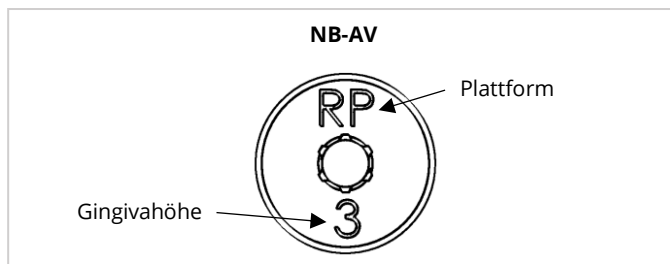

Zubehör Heli-Loc Abutments

Zubehör für Heli-Loc Abutments

unsteril

[KLICK ZUM WEBSHOP](#)

2x

**Abformpfosten
Heli-Loc (offen)**

2x

**Matrize
(Titan Grade 5)**

10x

Polymerisationseinsatz

**Extraktion und
Einführwerkzeug
für Kappen**

	REF	044CAIP-HE	141CTP-HE	100PDR-HE	488EIP-HE

Retentionseinsätze ohne Pin für Heli-Loc Abutments

unsteril

4x

4x

4x

4x

4x

	Farbe	Transparent	Rosa	Gelb	Lila	Schwarz
<i>Abzugskraft [kg/lbs]</i>		1kg / 2,20 lbs	0,8kg / 1,76 lbs	0,6 kg / 1,32 lbs	1,5kg / 3,30 lbs	Labor
<i>REF</i>		140CPT-HE	140CPP-HE	140CPG-HE	140CPV-HE	140CPN-HE
<i>Preis [EUR]</i>		17,50	17,50	17,50	17,50	17,50

Retentionseinsätze mit Pin für Heli-Loc Abutments

unsteril

4x

4x

4x

4x

4x

	Farbe	Transparent	Rosa	Gelb	Lila	Schwarz
<i>Abzugskraft [kg/lbs]</i>		1,5kg / 3,30 lbs	0,9kg / 1,98 lbs	0,7kg / 1,54 lbs	1,8kg / 3,96 lbs	Labor
<i>REF</i>		140CPPT-HE	140CPPP-HE	140CPPG-HE	140CPPV-HE	140CPPN-HE
<i>Preis [EUR]</i>		17,50	17,50	17,50	17,50	17,50

Achtung, die Retentionseinsätze sind nur kompatibel mit der Matrize REF 141CTP-HE

Laborsets für Heli-Loc Abutments

unsteril

Kappen ohne Pin

Kappen mit Pin

[KLICK ZUM WEBSHOP](#)

	REF	192CPS-HE	192CPC-HE
<i>Preis [EUR]</i>		25,-	25,-

Weitere kompatible Laboranaloge

Kompatibel zu Nobel Biocare® - Tri Lobe [Tri-Channel] - Nobel Replace® Tapered Groovy, NobelSpeedy Replace / NobelReplace® Straight / Replace Select Straight / Replace Select Tapered®

Titan Grade 5, unsteril, farbcodiert, für 3D Druck geeignet

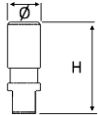

[Per Klick zum Webshop](#)

Plattform	NP	RP	WP
H [mm]	12	12	12
Ø [mm]	3,5	4,3	5,0
Farbcodierung	lila	gelb	blau
REF	24.001.35.010	24.002.43.010	24.003.50.010
Preis [EUR]	12,-	12,-	12,-
ab 10 Stk.	9,-	9,-	9,-
ab 30 Stk.	8,-	8,-	8,-

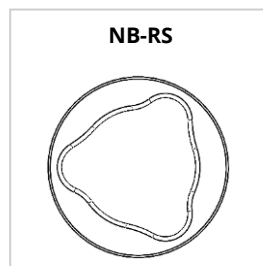

Kompatibel zu Bego® - Semados® (S / RI / RS / RSX / SC / SCX)

Titan Grade 5, unsteril, farbcodiert, für 3D Druck geeignet

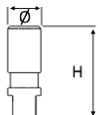

[KLICK ZUM WEBSHOP](#)



Plattform	3,25 / 3,75	4,1	4,5	5,5
H [mm]	12	12	12	12
Ø [mm]	3,67	4,1	4,5	5,5
Farbcodierung	blau	keine	lila	gelb
REF	24.089.37.120	24.090.41.120	24.091.45.120	24.092.55.120
Preis [EUR]	12,-	12,-	12,-	12,-
ab 10 Stk.	9,-	9,-	9,-	9,-
ab 30 Stk.	8,-	8,-	8,-	8,-

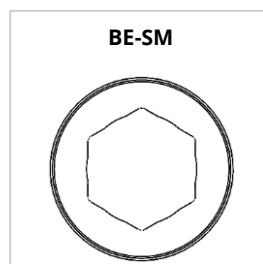

Weitere Laboranaloge

Kompatibel zu Medentis Medical® - ICX®

Titan Grade 5, unsteril, farbcodiert, für 3D Druck geeignet

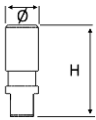

 [Per Klick zum Webshop](#)

Plattform	3,75 / 4,1 / 4,8
<i>H [mm]</i>	12
<i>Ø [mm]</i>	3,75
<i>Farbcodierung</i>	rot
<i>REF</i>	24.080.00.120
<i>Preis [EUR]</i>	12,-
<i>ab 10 Stk.</i>	9,-
<i>ab 30 Stk.</i>	8,-

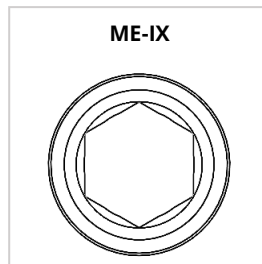

Heli-Loc

Titan Grade 5, unsteril, kompatibel zu Locator® und Locator®-kompatiblen Produkten

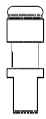

Plattform	4,0
<i>H [mm]</i>	12
<i>Ø [mm]</i>	4,0
<i>Farbcodierung</i>	keine
<i>REF</i>	24.106.40.120
<i>Preis [EUR]</i>	12,-
<i>ab 10 Stk.</i>	9,-
<i>ab 30 Stk.</i>	8,-

Passende Instrumente ab S. 85

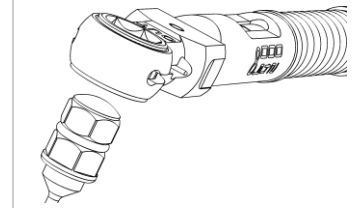

Löseinstrument für DS-AY Serie

Löseinstrument für DS-AY Serie (31.050.71.025)

Zur einfachen Entformung von DS-AY Abutments aus Laboranalogen und Dentsply - Ankylos Implantaten. Zuvor muss die Labor- oder Abutmentschraube entfernt werden. Durch vorsichtiges Drehen wird das DS-AY Abutment axial aus dem Implantat bzw. Analog gelöst.

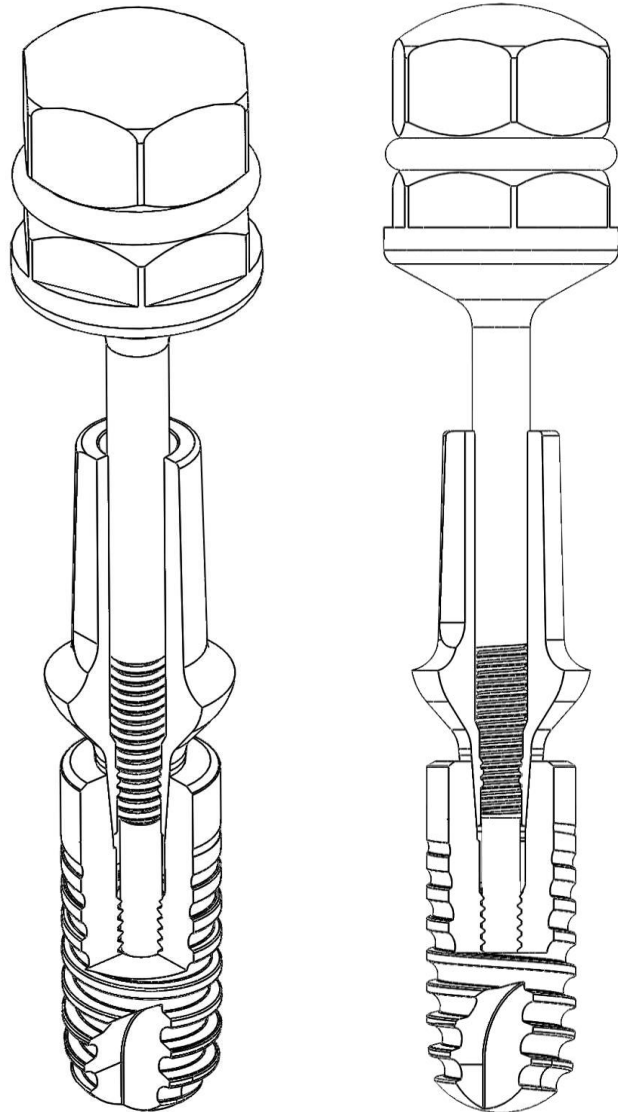

Instrumente

Drehmomentratsche und Universalratsche

[KLICK ZUM WEBSHOP](#)



Länge [mm]	110	54
Anschluss	Hex 6,4	Hex 6,4
Drehmoment	15 – 80 Ncm	-
REF	31.084.15.080	31.037.54.095
Preis [EUR]	150,-	75,-

Adapter und Handrad

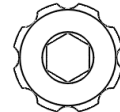
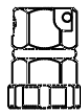

Instrument	Dental DIN EN ISO 1797	Dental DIN EN ISO 1797	Handrad
Anschluss	Hex 6,4	Ø 7 mm (z. B. Straumann®)	Hex 6,4
REF	31.034.64.110	31.035.70.110	31.036.64.060
Preis [EUR]	26,-	26,-	15,-

Torx® T6 - kompatibel zu SM-BL / SM-TL

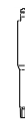

Anschluss	Hex 6,4	Hex 6,4	Dental DIN EN ISO 1797	Dental DIN EN ISO 1797
Instrument	Torx® T6	Torx® T6	Torx® T6	Torx® T6
Länge [mm]	25	31	25	31
REF	31.022.71.025	31.023.71.031	31.024.23.025	31.025.23.031
Preis [EUR]	30,-	30,-	15,-	15,-

Hex 1,26 - kompatibel zu AT-EV / AT-TX / CL-CO / CL-SR / ZMB

[KLICK ZUM WEBSHOP](#)



Anschluss	Hex 6,4	Hex 6,4	Dental DIN EN ISO 1797	Dental DIN EN ISO 1797
Instrument	Hex 1,26	Hex 1,26	Hex 1,26	Hex 1,26
Länge [mm]	25	31	25	31
REF	31.018.71.025	31.019.71.031	31.020.23.025	31.021.23.031
Preis [EUR]	30,-	30,-	15,-	15,-

Instrumente

Hex 1,22 - kompatibel zu FX



Anschluss	Hex 6,4	Hex 6,4	Dental DIN EN ISO 1797	Dental DIN EN ISO 1797
<i>Instrument</i>	Hex 1,22	Hex 1,22	Hex 1,22	Hex 1,22
<i>Länge [mm]</i>	25	31	25	31
<i>REF</i>	31.030.71.025	31.031.71.031	31.032.23.025	31.033.23.031
<i>Preis [EUR]</i>	30,-	30,-	15,-	15,-

Hex 1,01 - kompatibel zu DS-AY

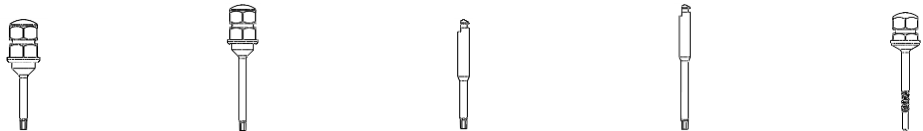

Anschluss	Hex 6,4	Hex 6,4	Dental DIN EN ISO 1797	Dental DIN EN ISO 1797	Hex 6,4
<i>Instrument</i>	Hex 1,01	Hex 1,01	Hex 1,01	Hex 1,01	Löseinstrument
<i>Länge [mm]</i>	25	31	25	31	
<i>REF</i>	31.038.71.025	31.039.71.031	31.040.23.025	31.041.23.031	31.050.71.025
<i>Preis [EUR]</i>	30,-	30,-	15,-	15,-	30,-

Hex 1,40 - kompatibel zu ME-IX



[KLICK ZUM WEBSHOP](#)

Anschluss	Hex 6,4	Dental DIN EN ISO 1797
<i>Instrument</i>	Hex 1,40	Hex 1,40
<i>Länge [mm]</i>	25	25
<i>REF</i>	31.042.71.025	31.044.23.025
<i>Preis [EUR]</i>	30,-	15,-

UniGrip - kompatibel zu NB-AV / NB-RS



[KLICK ZUM WEBSHOP](#)

Anschluss	Hex 6,4	Hex 6,4	Dental DIN EN ISO 1797	Dental DIN EN ISO 1797
<i>Instrument</i>	UG	UG	UG	UG
<i>Länge [mm]</i>	25	31	25	31
<i>REF</i>	31.026.71.025	31.027.71.031	31.028.23.025	31.029.23.031
<i>Preis [EUR]</i>	30,-	30,-	15,-	15,-

Eindrehinstrument Multi-Unit (Multi-Unit Serie) und Heli-Loc



Anschluss	Hex 6,4 (Ratsche)	Hex 6,4 (Ratsche)
<i>REF</i>	31.030.00.188	31.051.64.020
<i>Preis [EUR]</i>	30,-	30,-

Installationsanleitung der Heliocos Bibliotheken

Unter <https://www.heliocos.de/medien> finden Sie die Anleitung zum Download und zur Installation der Heliocos Bibliotheken.

Hinweise für Exocad®

1. Wählen Sie die passende Heliocos Serie

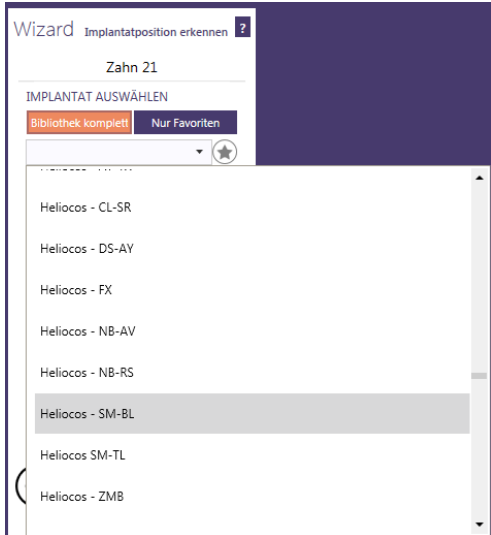

Heliocos Serie	Exocad Abkürzung	Kompatibel zu:
SM-BL	STR-BL	Straumann® - Bone Level
SM-TL	STR-TL	Straumann® - Tissue Level
CL-SR	CL-SL	Camlog® - Screw Line, Root-Line2®
CL-CO	CL-COL	Camlog® - Conelog®
FX	FX	Dentsply® - Xive® S
DS-AY	DS-ANK	Dentsply® - Ankylos®
AT-EV	DS-OSSEV	Dentsply® - Astra Tech® OsseoSpeed™ EV
AT-TX	DS-OSSTX	Dentsply® - Astra Tech® OsseoSpeed™ TX
NB-AV	NB-AV	Nobel Biocare® - Conical Connection (Active)
ZMB	ZI	Zimmer Dental® / MIS® / Biohorizons® - Hex
Multi-Unit	Multi-Unit	Unabhängig, da Scan auf Abutmentniveau

2. Wählen Sie die gewünschte Plattform (Durchmesser)



3. Wählen Sie die gewünschte Versorgung

Ti Base B H4

→ Kaminhöhe, hier 4 mm

→ Ausrichtung der Abwinkelung

→ Titanbasis / Klebebasis

rot = rotatorisch / ohne Index

Pre-Mill = Fräsrohling für individuelles Abutment, Rohling-Ø = 11,5 mm

Hinweise für 3shape®

1. Wählen Sie in der Kategorie „Heliocos“

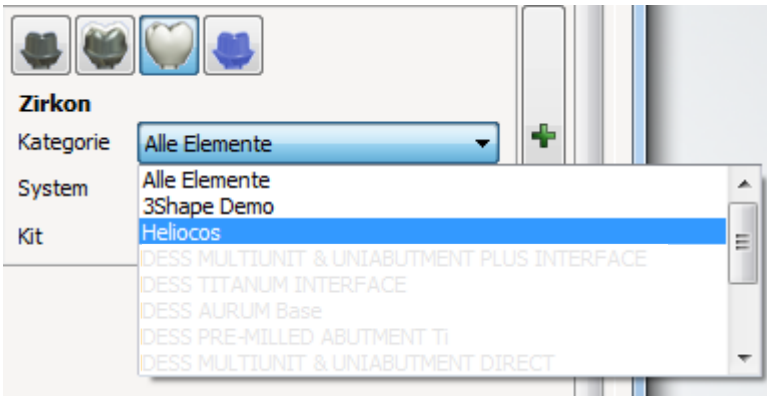

2. Wählen Sie die passende Heliocos Serie

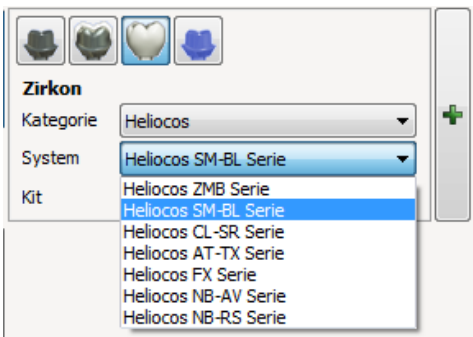

Heliocos Serie	Kompatibel zu:
SM-BL	Straumann® - Bone Level
SM-TL	Straumann® - Tissue Level
CL-SR	Camlog® - Screw Line, Root-Line2®
CL-CO	Camlog® - Conelog®
FX	Dentsply® - Xive® S
DS-AY	Dentsply® - Ankylos®
AT-EV	Dentsply® - Astra Tech® OsseoSpeed™ EV
AT-TX	Dentsply® - Astra Tech® OsseoSpeed™ TX
NB-AV	Nobel Biocare® - Conical Connection (Active)
ZMB	Zimmer Dental® / MIS® / Biohorizons® - Hex
Multi-Unit	Unabhängig, da Scan auf Abutmentniveau

3. Wählen Sie die passende Plattform und die gewünschte Versorgung

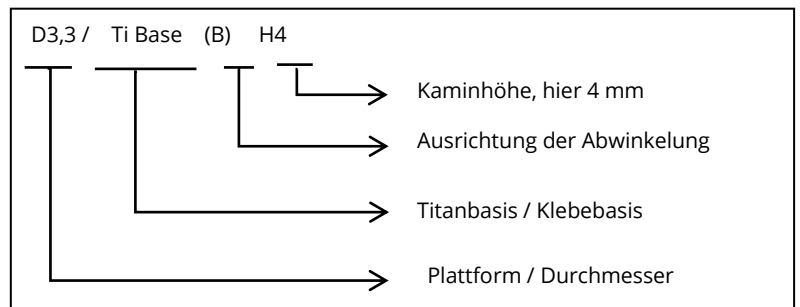
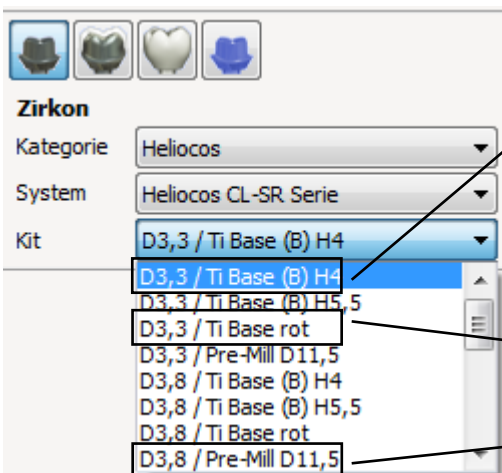

rot = rotatorisch / ohne Index

Pre-Mill = Fräsrohling für individuelles Abutment, Rohling-Ø = 11,5 mm

Etiketten

Etiketten

Vorderseite

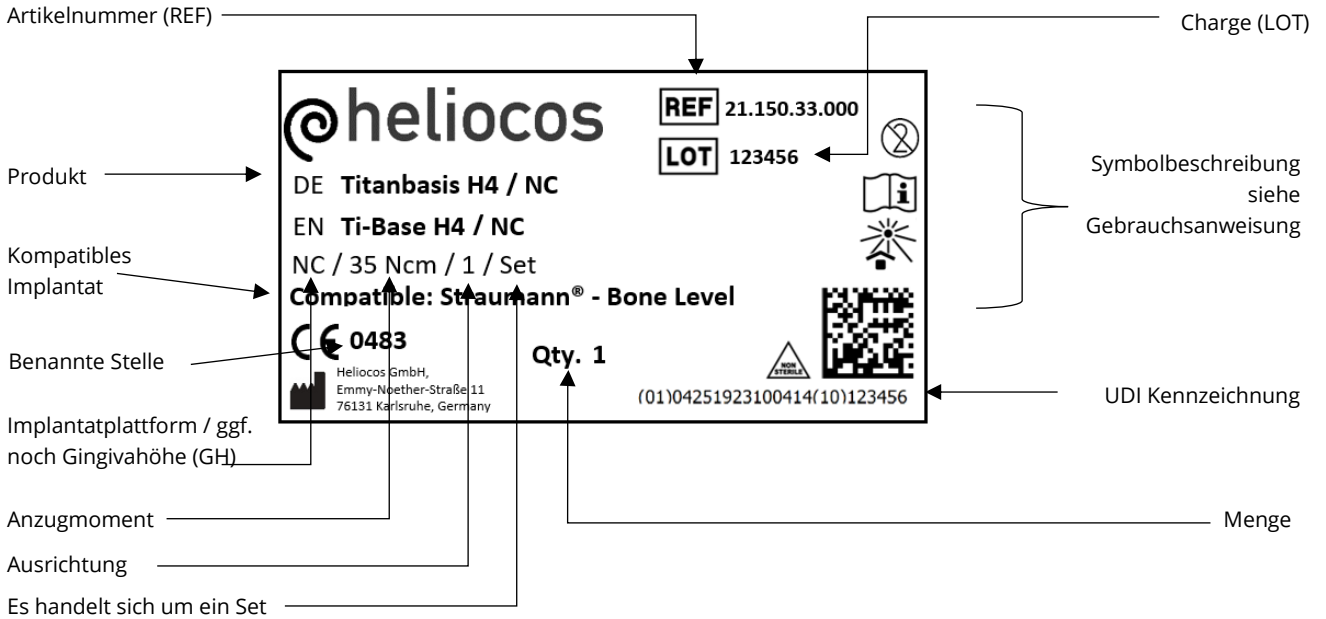

Rückseite

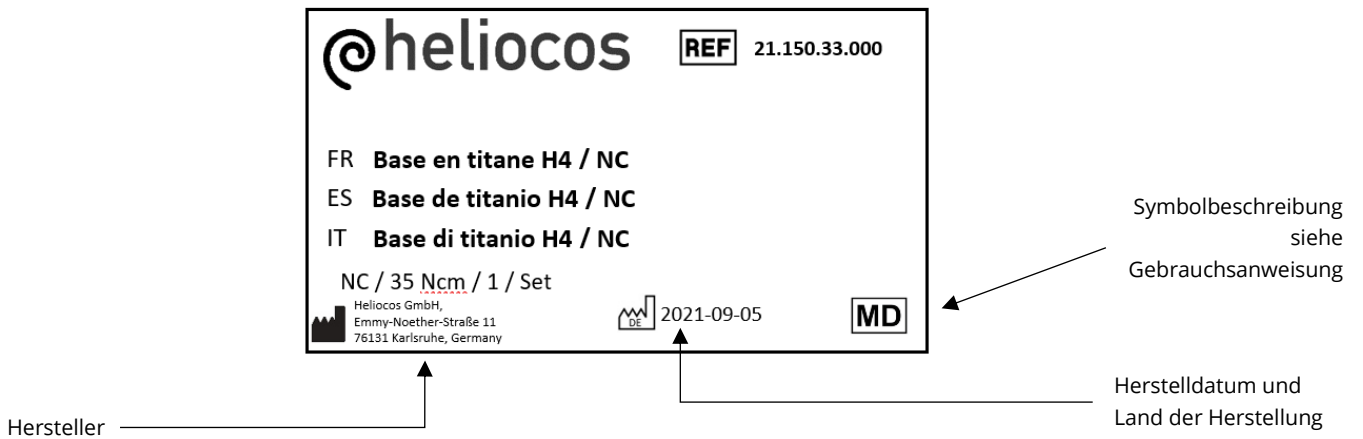

Patientenetikett

Patientenetikett für den Implantatpass (Zwei Etiketten pro Verpackung)

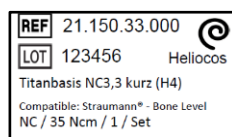

Drehmomente

Drehmomente

Achtung:

Die genannten Drehmomente gelten für den klinischen Bereich und dürfen nicht im Labor angewendet werden.

Drehmoment [Ncm]	Abutment-Serie (Produkt)
15	AT-TX 3,0, NB-AV 3,0 / Multi-Unit Brückenschrauben (alle Serien)
20	CL-CO, CL-SR
25	AT-EV, AT-TX, DS-AY, FX
30	ME-IX, ZMB, CL-SR Multi-Unit Abutments (gerade) 3,8 – 6,0, CL-SR Heli-Loc Abutments (gerade) 3,8 – 6,0
35	NB-AV, NB-RS, SM-BL, SM-TL
Leicht handfest	Scanbodys / Abformpfosten / Gingivaformer / Multi-Unit Verschlusskappe

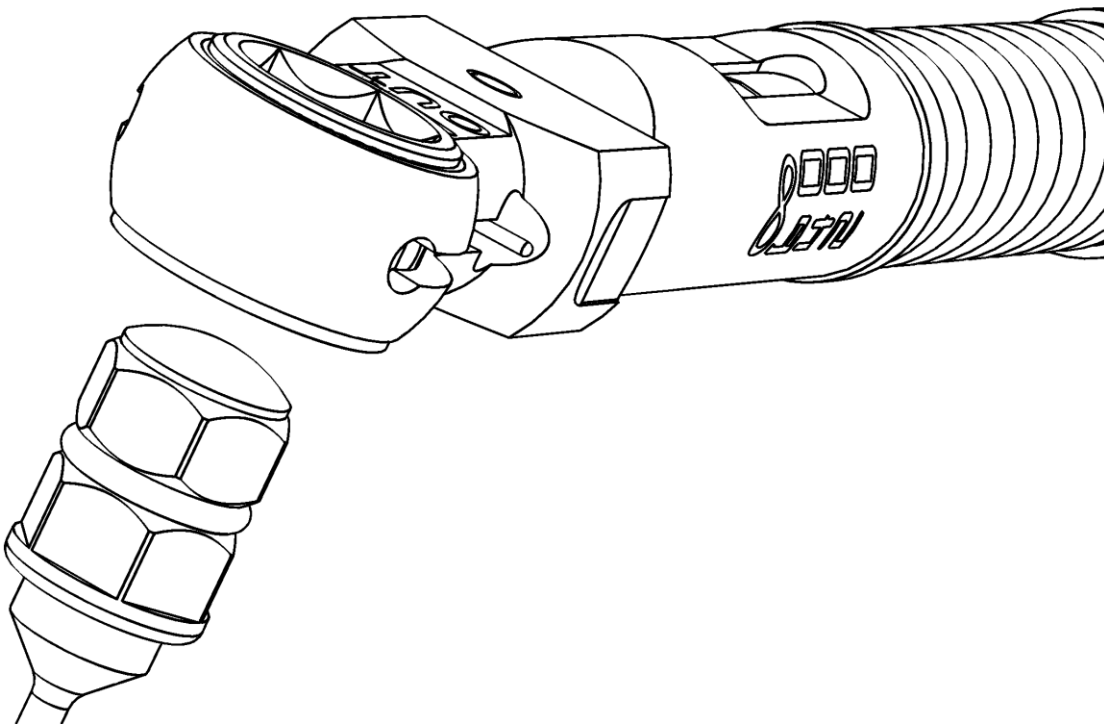

Die rechtliche Situation bei kompatiblen Produkten



Es besteht kein rechtliches Risiko, wenn der Behandler unsere Abutments/Produkte mit den Implantaten kombiniert. Die Zuordnung steht in der Gebrauchsanweisung und auf dem Etikett. Wichtig ist, dass sich der Behandler an die Zuordnung hält.

Die Gewährleistung bzw. die Sachmängelhaftung



Jeder Hersteller haftet für Mängel seines Produktes. Das gilt auch, wenn dieses mit anderen Teilen kombiniert wird. Wir haften für unsere Produkte, so wie die Hersteller der Implantate für ihre haften müssen.

Die Garantie



Sie erhalten 30 Jahre Garantie, weil wir von unseren Produkten überzeugt sind. Die Garantie ist eine freiwillige Leistung.

IMPRESSUM

Emmy-Noether-Str. 11 | 76131 Karlsruhe | Germany
Tel +49 (0)721 75 40 36 40 | Fax +49 (0)721 75 40 36 34
info(at)heliocos.de | www.heliocos.de

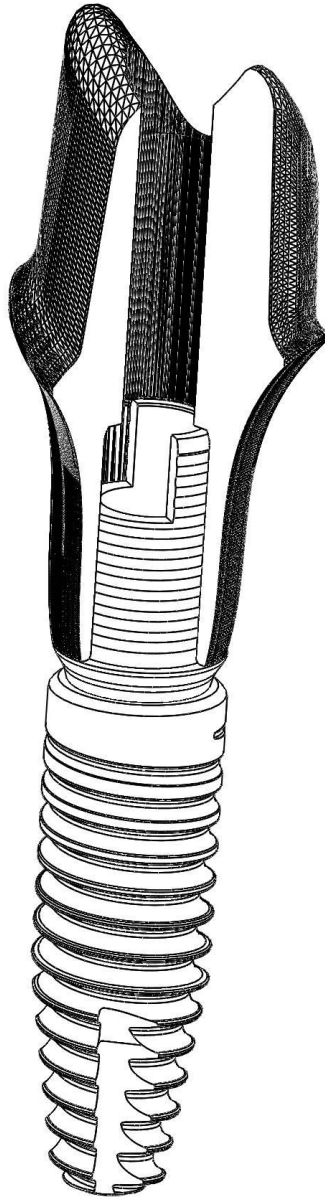

Emmy-Noether-Str. 11 | 76131 Karlsruhe
Tel +49 (0)721 75 40 36 40
Fax +49 (0)721 75 40 36 34
www.helioscos.de | info@helioscos.de