



heliocos
zertifizierte
Kompatibilität



ABUTMENTS

Made in Germany

Inhaltsverzeichnis

Über Heliocos	7
Sicherheit.....	7
Made in Germany.....	7
Versand.....	7
Bestellinformationen	7
SM-BL Serie – kompatibel zu Straumann® - Bone Level	8
Abutmentschrauben	9
Laborschrauben.....	9
Laboranaloge	9
Gerade Abutments	9
Gewinkelte Abutments.....	10
Titanbasen kurz, CAD/CAM.....	10
Titanbasen lang, CAD/CAM.....	10
Titanbasen nicht indexiert, CAD/CAM	10
Scanbodys	11
Pre-Mill Abutments.....	11
Multi-Unit Abutments NC	11
Multi-Unit Abutments RC.....	11
Multi-Unit Zubehör	12
Abformpfosten kurz (offene Abformung).....	12
Abformpfosten lang (offene Abformung)	12
Abformpfosten (geschlossene Abformung).....	12
Gingivaformer	13
SM-TL Serie - kompatibel zu Straumann® - Tissue Level	14
Abutmentschrauben	15
Laborschrauben.....	15
Laboranaloge	15
Gerade Abutments	16
Gewinkelte Abutments.....	16
Titanbasen kurz, CAD/CAM.....	16
Titanbasen lang, CAD/CAM.....	17
Titanbasen nicht indexiert, CAD/CAM	17
Scanbodys	17
Pre-Mill Abutments.....	17
Multi-Unit Abutments.....	18
Multi-Unit Zubehör	18
Abformpfosten kurz (offene Abformung).....	18
Abformpfosten lang (offene Abformung)	18
Abformpfosten (geschlossene Abformung).....	19
Gingivaformer	19
CL-SR Serie - kompatibel zu Camlog® - Screw-Line / Root-Line2®	20
Abutmentschrauben	21

Inhaltsverzeichnis

Laborschrauben.....	21
Laboranaloge	21
Gerade Abutments	22
Gewinkelte Abutments.....	22
Massivabutments	23
Titanbasen kurz, CAD/CAM.....	23
Titanbasen lang, CAD/CAM.....	23
Titanbasen nicht indexiert, CAD/CAM	23
Scanbodys	24
Pre-Mill Abutments.....	24
Multi-Unit Abutments 3,8	24
Multi-Unit Abutments 4,3 / 5,0	24
Multi-Unit Zubehör	25
Abformpfosten kurz (offene Abformung)	25
Abformpfosten lang (offene Abformung)	25
Abformpfosten (geschlossene Abformung).....	25
Gingivaformer	26
CL-CO Serie - kompatibel zu Camlog® - Conelog®	27
Abutmentschrauben	28
Laborschrauben.....	28
Laboranaloge	28
Gerade Abutments	29
Gewinkelte Abutments.....	29
Titanbasen kurz, CAD/CAM.....	29
Titanbasen lang, CAD/CAM.....	30
Titanbasen nicht indexiert, CAD/CAM	30
Scanbodys	30
Pre-Mill Abutments.....	30
Multi-Unit Abutments.....	31
Multi-Unit Zubehör	31
Abformpfosten kurz (offene Abformung)	31
Abformpfosten lang (offene Abformung)	31
Abformpfosten (geschlossene Abformung).....	32
Gingivaformer	32
AT-TX Serie - kompatibel zu Dentsply® - Astra Tech® OsseoSpeed® TX	33
Abutmentschrauben	34
Laborschrauben.....	34
Laboranaloge	34
Gerade Abutments	35
Gewinkelte Abutments.....	35
Titanbasen kurz, CAD/CAM.....	36
Titanbasen lang, CAD/CAM.....	36
Titanbasen nicht indexiert, CAD/CAM	36
Scanbodys	37

Inhaltsverzeichnis

Pre-Mill Abutments.....	37
Multi-Unit Abutments D3,5 / 4,0	37
Multi-Unit Abutments D4,5 / 5,0	37
Multi-Unit Zubehör	38
Abformpfosten kurz (offene Abformung)	38
Abformpfosten lang (offene Abformung)	38
Abformpfosten (geschlossene Abformung).....	38
Gingivaformer	39
AT-EV Serie - kompatibel zu Dentsply® - Astra Tech® EV™	40
Abutmentschrauben	41
Laborschrauben.....	41
Laboranaloge	41
Gerade Abutments	42
Gewinkelte Abutments.....	42
Titanbasen kurz, CAD/CAM.....	43
Titanbasen lang, CAD/CAM.....	43
Titanbasen nicht indexiert, CAD/CAM	43
Scanbodys	44
Pre-Mill Abutments.....	44
Multi-Unit Abutments D3,6.....	44
Multi-Unit Abutments D4,2.....	44
Multi-Unit Abutments D4,8.....	44
Multi-Unit Zubehör	45
Abformpfosten kurz (offene Abformung)	45
Abformpfosten lang (offene Abformung)	45
Abformpfosten (geschlossene Abformung).....	45
Gingivaformer	46
FX Serie - kompatibel zu Dentsply® - Xive® S	47
Abutmentschrauben	48
Laborschrauben.....	48
Laboranaloge	48
Gerade Abutments	49
Gewinkelte Abutments / 15 Grad.....	49
Gewinkelte Abutments / 25 Grad.....	49
Titanbasen kurz, CAD/CAM.....	50
Titanbasen lang, CAD/CAM.....	50
Titanbasen nicht indexiert, CAD/CAM	50
Scanbodys	50
Pre-Mill Abutments.....	51
Multi-Unit Abutments D3,4.....	51
Multi-Unit Abutments D3,8.....	51
Multi-Unit Abutments D4,5.....	51
Multi-Unit Zubehör	52
Abformpfosten kurz (offene Abformung)	52

Inhaltsverzeichnis

Abformpfosten lang (offene Abformung)	52
Abformpfosten (geschlossene Abformung).....	52
Gingivaformer	53
DS-AY Serie - kompatibel zu Dentsply® – Ankylos® C/X.....	54
Abutmentschrauben	55
Laborschrauben.....	55
Laboranaloge	55
Gerade Abutments	55
Gewinkelte Abutments (X)	56
Nicht indexierte Abutments (C).....	56
Titanbasen, CAD/CAM	56
Scanbodys	57
Pre-Mill Abutments.....	57
Multi-Unit Abutments.....	57
Multi-Unit Zubehör	57
Abformpfosten (offene Abformung).....	58
Abformpfosten (geschlossene Abformung).....	58
Gingivaformer	58
ZMB Serie - kompatibel zu Zimmer Dental® - TSRV / MIS® – Seven® / Biohorizons® - Internal Hex.....	59
Abutmentschrauben	60
Laborschrauben.....	60
Laboranaloge	60
Gerade Abutments	61
Gewinkelte Abutments / 15 Grad.....	61
Gewinkelte Abutments / 25 Grad.....	61
Titanbasen kurz, CAD/CAM.....	62
Titanbasen lang, CAD/CAM.....	62
Titanbasen nicht indexiert, CAD/CAM	62
Scanbodys	63
Pre-Mill Abutments.....	63
Multi-Unit Abutments D3,5.....	63
Multi-Unit Abutments D4,5.....	63
Multi-Unit Zubehör	64
Abformpfosten kurz (offene Abformung)	64
Abformpfosten lang (offene Abformung)	64
Abformpfosten (geschlossene Abformung).....	64
Gingivaformer	65
NB-AV Serie - kompatibel zu Nobel Biocare® - NobelActive® / NobelParallel™ / NobelReplace® Conical Connection.....	66
Abutmentschrauben	67
Laborschrauben.....	67
Laboranaloge	67
Gerade Abutments	68
Gewinkelte Abutments.....	68
Titanbasen kurz, CAD/CAM.....	69

Inhaltsverzeichnis

Titanbasen lang, CAD/CAM.....	69
Titanbasen nicht indexiert, CAD/CAM	69
Scanbodys	70
Pre-Mill Abutments.....	70
Multi-Unit Abutments NP.....	70
Multi-Unit Abutments RP	70
Multi-Unit Zubehör	71
Abformpfosten kurz (offene Abformung).....	71
Abformpfosten lang (offene Abformung)	71
Abformpfosten (geschlossene Abformung).....	71
Gingivaformer	72
Weitere kompatible Laboranaloge.....	73
Kompatibel zu Nobel Biocare® - Nobel Replace Tapered®	73
Kompatibel zu Bego® - Semandos® (S / RI / RS / RSX / SC / SCX)	73
Kompatibel zu Medentis Medical® - ICX®	74
Heli-Loc	74
Löseinstrument für DS-AY Serie	75
Instrumente	76
Drehmomentratsche und Universalratsche	76
Adapter und Handrad	76
Torx® T6 - kompatibel zu SM-BL / SM-TL	76
Hex 1,26 - kompatibel zu AT-EV / AT-TX / CL-CO / CL-SR / ZMB	76
Hex 1,20 - kompatibel zu FX	77
Hex 1,01 - kompatibel zu DS-AY	77
Hex 1,40 - kompatibel zu ME-IX	77
UniGrip - kompatibel zu NB-AV / NB-RS	77
Eindrehinstrument Multi-Unit (Multi-Unit Serie).....	77
Installationsanleitung der Heliocos Bibliotheken.....	78
Hinweise für Exocad®.....	78
Hinweise für 3shape®.....	79
Etiketten	80
Wissenswertes zur rechtlichen Situation.....	81
Die rechtliche Situation bei kompatiblen Produkten.....	81
Die Gewährleistung bzw. die Sachmängelhaftung.....	81
Die Garantie	81

Über Heliocos

Sicherheit

Langjährige Erfahrung in der Dentalbranche und hervorragendes technologisches Verständnis führen zu perfekten Produkten. Höchste Präzision an der Schnittstelle zum Implantat und durchdachte Schraubverbindungen führen zu sehr guten Ergebnissen in der Ermüdungsprüfung nach DIN EN ISO 14801. Wir erfüllen alle behördlichen und normativen Anforderungen. Unser Qualitätsmanagementsystem ist nach DIN EN ISO 13485 zertifiziert. Ebenfalls ist unser Qualitätssicherungssystem nach RL 93/42/EWG Anhang II zertifiziert.

Made in Germany

Unsere Produkte werden in Deutschland produziert, das ist uns wichtig. Mit einer hervorragenden Qualität und einem attraktiven Preis-Leistungs-Verhältnis überzeugen wir unsere Kunden.

Versand

Bestelleingang

Montag – Freitag 8:00 – 16:00 Uhr

Zustellung am nächsten Arbeitstag

Tagesende (nur Deutschland) € 7,50 netto

bis 12 Uhr (nur Deutschland) € 12,00 netto

Bei Bestellwert über 250 € (netto) werden 7,50 € Versandkosten erlassen.

- Internationale Versandkosten finden Sie auf unserem Webshop.

Bestellinformationen

Webshop: <https://shop.heliocos.de/>

E-Mail: vertrieb@heliocos.de

Fon: +49 721 75 40 36 31 / Fax: +49 721 75 40 36 34

Alle Preise zzgl. gesetzlicher Mehrwertsteuer.



SM-BL Serie – kompatibel zu **Straumann®** - Bone Level

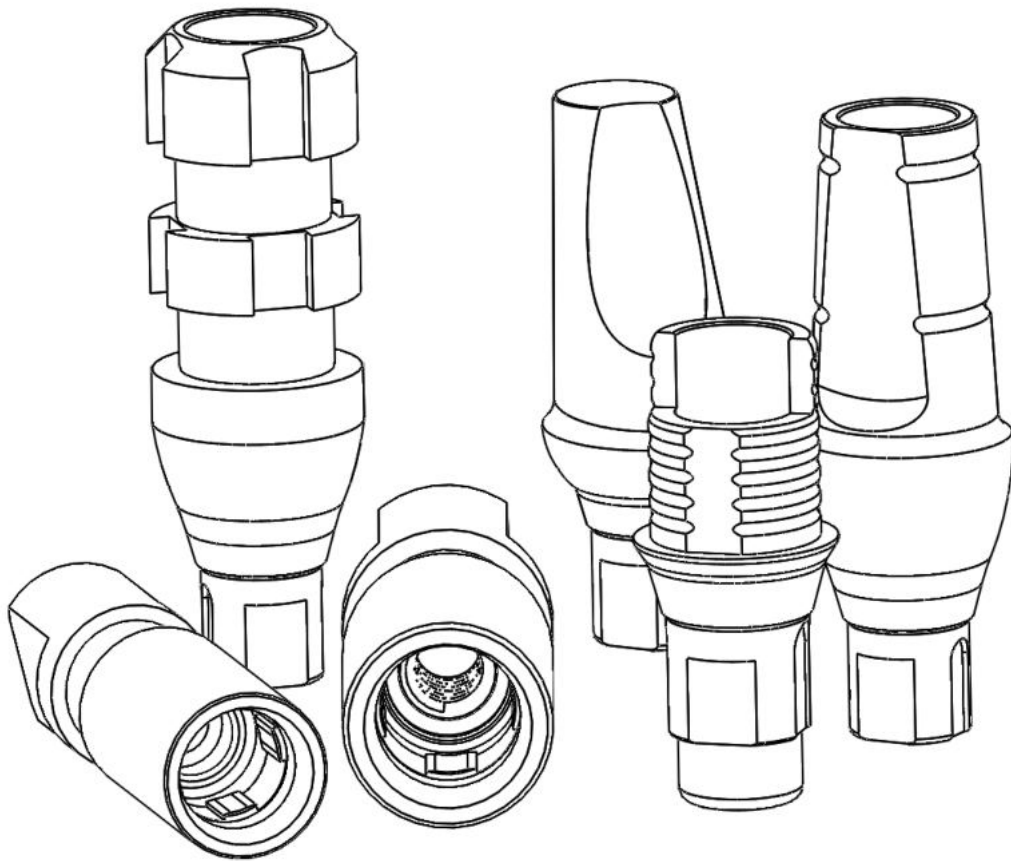

SM-BL Serie – kompatibel zu Straumann® - Bone Level

Abutmentschrauben

Titan Grade 5, unsteril, Anschluss: Torx® T6



 [Per Klick zum Webshop](#)

Plattform	NC / RC	Multi-Unit
Größe	M 1,6	M 1,4
REF	21.338.00.085	21.183.21.035
Preis [EUR]	10,-	10,-

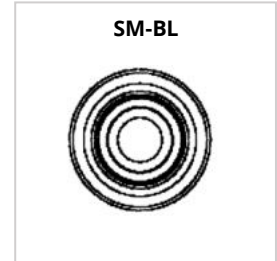

Laborschrauben

Titan Grade 5, unsteril, Anschluss: Torx® T6, farbcodiert gelb



Plattform	NC / RC	Multi-Unit
Größe	M 1,6	M 1,4
REF	24.009.00.085	24.108.21.035
Preis [EUR]	6,-	6,-
Ab 5 Stk.	4,-	4,-
Ab 10 Stk.	3,50	3,50

Laboranaloge

Titan Grade 5, unsteril, farbcodiert, 3D Druck geeignet

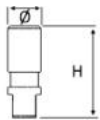

Plattform	NC	RC
H [mm]	12	12
Ø [mm]	3,3	4,1
Farbcodierung	gelb	lila
REF	24.007.33.010	24.008.00.010
Preis [EUR]	12,-	12,-
Ab 10 Stk.	9,-	9,-
Ab 30 Stk.	8,-	8,-

Passende Instrumente ab S. 76

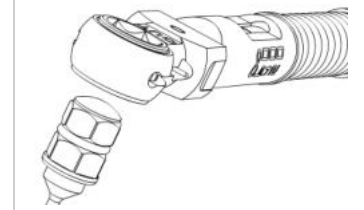

Gerade Abutments

Titan Grade 5, unsteril, inkl. Schraube / Drehmoment: 35 Ncm

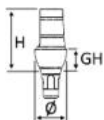

 [KLICK ZUM WEBSHOP](#)

Plattform	NC	NC	RC	RC
GH [mm]	1,5	3	1,5	3
H [mm]	8	8	9,6	9,6
Ø [mm]	4,2	4,2	5	5
REF	21.116.33.000	21.118.33.000	21.117.00.000	21.119.00.000
Preis [EUR]	60,-	60,-	60,-	60,-

Gewinkelte Abutments

Titan Grade 5, unsteril, inkl. Schraube / Drehmoment: 35 Ncm

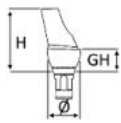

[KLICK ZUM WEBSHOP](#)

	Plattform	NC	NC	RC	RC
	GH [mm]	1,5	3	1,5	3
	H [mm]	7,7	7,7	8,1	8,1
	Ø [mm]	4,2	4,2	5	5
REF	Typ 2 (18°)	21.126.33.000	21.134.33.000	21.127.00.000	21.135.00.000
	Preis [EUR]	75,-	75,-	75,-	75,-

Titanbasen kurz, CAD/CAM

Titan Grade 5, unsteril, inkl. Schraube / Drehmoment: 35 Ncm / kompatibel mit: Exocad® & 3shape®

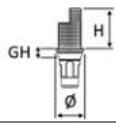

Passende Instrumente ab S. 76

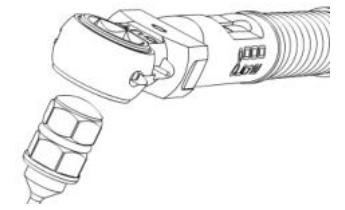

	Plattform	NC	RC
	GH [mm]	1	0,8
	H [mm]	4	4
	Ø [mm]	3,7	4
REF	Typ 1	21.150.33.000	21.151.00.000
	Preis [EUR]	45,-	45,-

Titanbasen lang, CAD/CAM

Titan Grade 5, unsteril, inkl. Schraube / Drehmoment: 35 Ncm / kompatibel mit: Exocad® & 3shape®

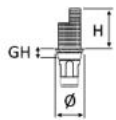

[Per Klick zum Webshop](#)

	Plattform	NC	RC
	GH [mm]	1	0,8
	H [mm]	5,5	5,5
	Ø [mm]	3,7	4
REF	Typ 1	21.154.33.000	21.155.00.000
	Preis [EUR]	45,-	45,-

Titanbasen nicht indiziert, CAD/CAM

Titan Grade 5, unsteril, inkl. Schraube / Drehmoment: 35 Ncm / ohne Rotationsschutz / kompatibel mit: Exocad® & 3shape®

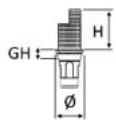

	Plattform	NC	RC
	GH [mm]	1	0,8
	H [mm]	3,5	3,5
	Ø [mm]	3,7	4,3
REF	Typ 1	21.159.33.000	21.160.00.000
	Preis [EUR]	40,-	40,-

Scanbodys

Titan Grade 4, unsteril, inkl. Schraube / Drehmoment: Handfest



Plattform	NC	RC
REF	21.336.33.147	21.337.00.147
Preis [EUR]	30,-	30,-

Scanbodys sind wieder aufbereitbar und für den intraoralen Einsatz geeignet.

Pre-Mill Abutments

Titan Grade 5, unsteril, inkl. Schraube / Drehmoment: 35 Ncm, kompatibel zum Medentika®-Halter



Plattform	NC	RC	RC
Ø [mm]	11,5	11,5	15,8
REF	25.029.11.000	25.037.11.000	25.039.15.000
Preis [EUR]	37,-	37,-	37,-

Multi-Unit Abutments NC

Titan Grade 5, unsteril / Drehmoment: 35 Ncm

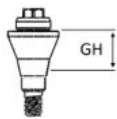

Per Klick zum Webshop

Plattform	NC	NC	NC
GH [mm]	1,5	2,5	3,5
REF	21.164.33.087	21.165.33.097	21.166.33.107
Preis [EUR]	49,-	49,-	49,-

Multi-Unit Abutments RC

Titan Grade 5, unsteril / Drehmoment: 35 Ncm

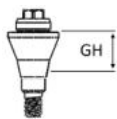

Plattform	RC	RC	RC	RC
GH [mm]	1,5	2,5	3,5	4,5
REF	21.169.00.088	21.170.00.098	21.171.00.108	21.172.00.118
Preis [EUR]	49,-	49,-	49,-	49,-



Multi-Unit Zubehör

Titan Grade 5, unsteril, Anschluss: Torx® T6

[KLICK ZUM WEBSHOP](#)



Titanbasis Multi-Unit, CAD/CAM **Titankappe Multi-Unit** **Gingivaformer Multi-Unit** **Scanbody Multi-Unit** **Abformpfosten Multi-Unit (offene Abformung)** **Laboranalog Multi-Unit**

<i>Material inkl. Schraube</i>	Titan Grade 5	Titan Grade 5	Titan Grade 5	Titan Grade 4	Titan Grade 5	Titan Grade 5
<i>Drehmoment</i>	ja	ja	nein	ja	ja	nein
<i>REF</i>	15 Ncm	15 Ncm	Handfest	Handfest	Handfest	-
<i>Preis [EUR]</i>	21.187.42.000	21.185.30.000	21.182.45.037	21.321.00.000	23.032.45.000	24.048.45.100
	39,-	39,-	18,-	30,-	26,-	12,-

Abformpfosten kurz (offene Abformung)

Titan Grade 5, unsteril, inkl. Schraube, farbcodiert / Drehmoment: Handfest

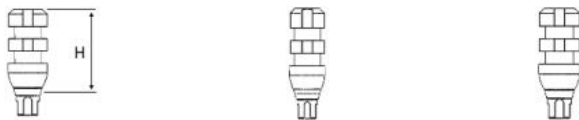

Plattform	NC	RC
<i>H [mm]</i>	10	10
<i>Farbcodierung</i>	gelb	lila
<i>REF</i>	23.023.33.000	23.024.00.000
<i>Preis [EUR]</i>	26,-	26,-

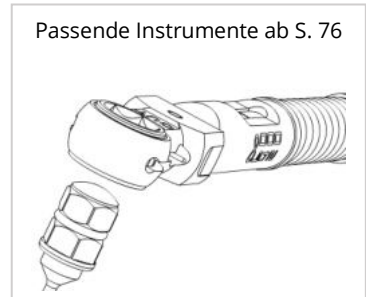

Abformpfosten lang (offene Abformung)

Titan Grade 5, unsteril, inkl. Schraube, farbcodiert / Drehmoment: Handfest

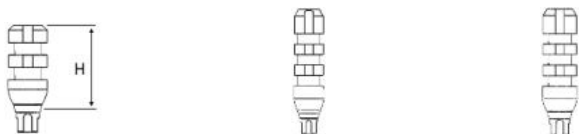

[Per Klick zum Webshop](#)

Plattform	NC	RC
<i>H [mm]</i>	15	15
<i>Farbcodierung</i>	gelb	lila
<i>REF</i>	23.028.33.000	23.029.00.000
<i>Preis [EUR]</i>	26,-	26,-

Abformpfosten (geschlossene Abformung)

Titan Grade 5, unsteril, inkl. Schraube and Kappe, farbcodiert / Drehmoment: Handfest



Plattform	NC	RC	Reponierkappen 5 Stk.
<i>H [mm]</i>	10	10	
<i>Farbcodierung</i>	gelb	lila	transparent
<i>REF</i>	23.249.33.011	23.250.41.011	23.999.48.000
<i>Preis [EUR]</i>	29,-	29,-	12,-

SM-BL Serie – kompatibel zu Straumann® - Bone Level

Gingivaformer

Titan Grade 5, unsteril, lasermarkiert / Drehmoment: Handfest

**KLICK ZUM
WEBSHOP**

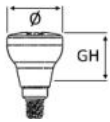

Plattform	NC	NC	NC	RC	RC	RC
GH [mm]	3	4	5	3	4	5
Ø [mm]	4,5	4,5	4,5	4,9	4,9	4,9
REF	22.569.33.030	22.570.33.040	22.571.33.050	22.572.41.030	22.573.41.040	22.574.41.050
Preis [EUR]	18,-	18,-	18,-	18,-	18,-	18,-

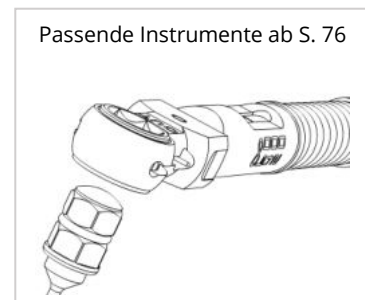
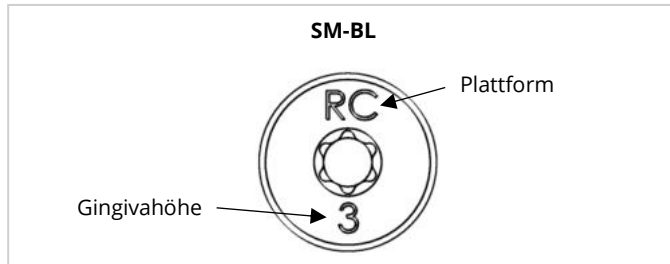

SM-TL Serie - kompatibel zu **Straumann®** - Tissue Level

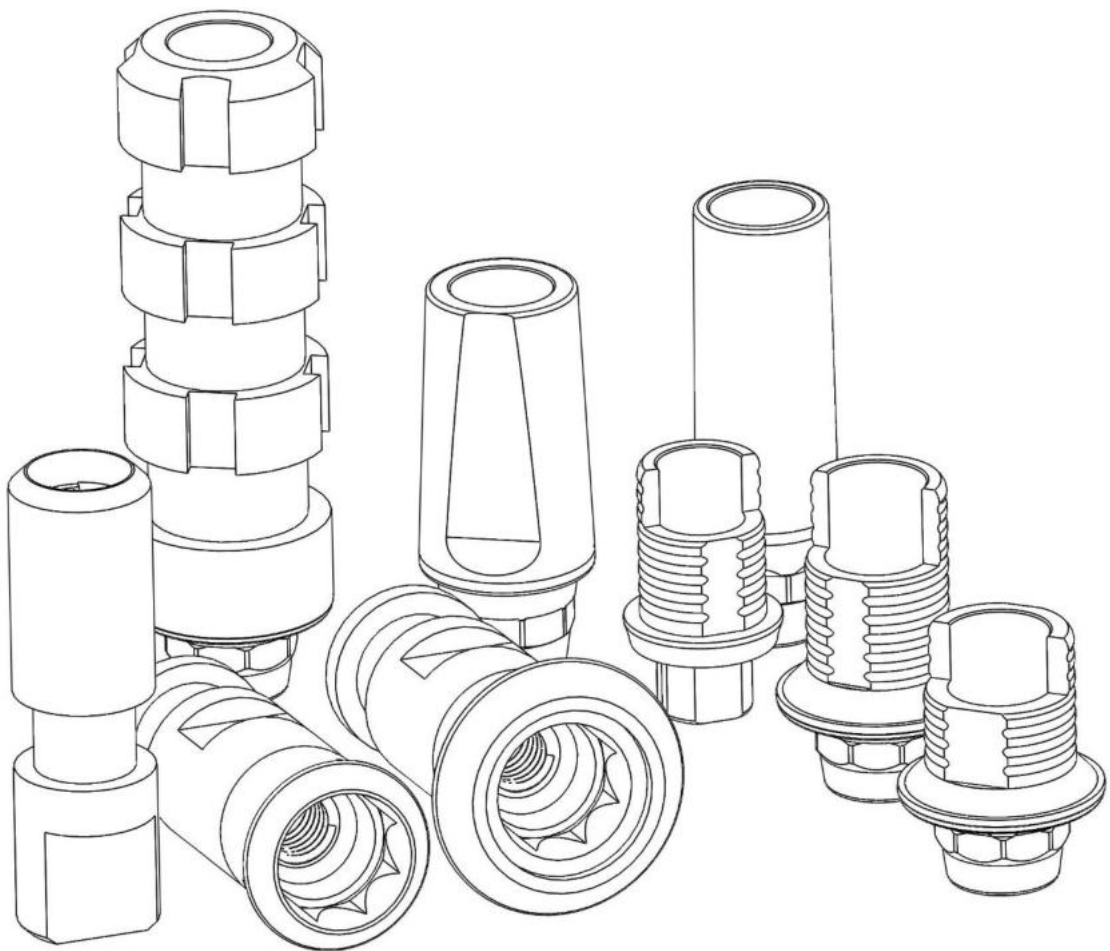

SM-TL Serie – kompatibel zu Straumann® - Tissue Level

Abutmentschrauben

Titan Grade 5, unsteril, Anschluss: Torx® T6



Plattform	NNC	RN / WN	Multi-Unit
Größe	M 1,6	M 2,0	M 1,4
REF	22.199.16.071	22.200.20.067	21.183.21.035
Preis [EUR]	10,-	10,-	10,-

Laborschrauben

Titan Grade 5, unsteril, Anschluss: Torx® T6, farbcodiert gelb



**KLICK ZUM
WEBSHOP**

Plattform	NNC	RN / WN	Multi-Unit
Größe	M 1,6	M 2,0	M 1,4
REF	24.066.16.071	24.067.20.065	24.108.21.035
Preis [EUR]	6,-	6,-	6,-
Ab 5 Stk.	4,-	4,-	4,-
Ab 10 Stk.	3,50	3,50	3,50

Laboranaloge

Titan Grade 5, unsteril, farbcodiert

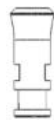
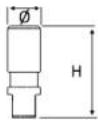

Plattform	NNC	RN	RN*	WN	WN*
H [mm]	12	12	12	12	9
Ø [mm]	3,5	4,8	4,8	6,5	6,5
Farbcodierung	keine	rot	rot	grün	grün
REF	24.063.35.010	24.064.48.010	24.103.48.120	24.065.65.010	24.104.65.100
Preis [EUR]	12,-	12,-	12,-	12,-	12,-
Ab 10 Stk.	9,-	9,-	9,-	9,-	9,-
Ab 30 Stk.	8,-	8,-	8,-	8,-	8,-

*) Für 3D gedruckte Modelle geeignet.

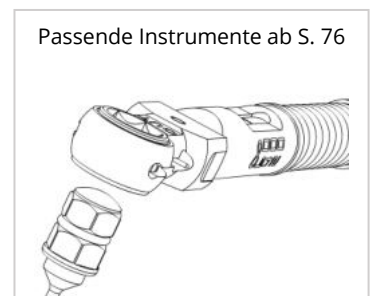
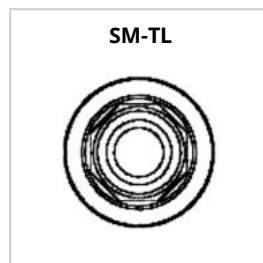

Passende Instrumente ab S. 76

Gerade Abutments

Titan Grade 5, unsteril, inkl. Schraube / Drehmoment: 35 Ncm



 [Per Klick zum Webshop](#)

	Plattform	RN	WN
<i>H [mm]</i>		8	8
<i>REF</i>		22.223.48.000	22.224.65.000
<i>Preis [EUR]</i>		60,-	60,-

Gewinkelte Abutments

Titan Grade 5, unsteril, inkl. Schraube / Drehmoment: 35 Ncm

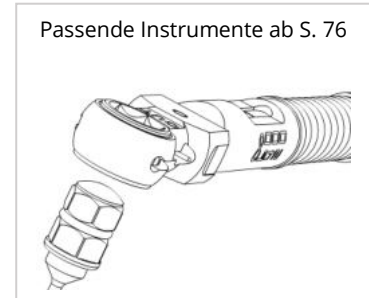

	Plattform	RN
<i>H [mm]</i>		7
<i>REF</i>	Typ 2 (15°)	22.235.48.000
<i>REF</i>	Typ 2 (25°)	22.247.48.000
<i>Preis [EUR]</i>		75,-



Titanbasen kurz, CAD/CAM

Titan Grade 5, unsteril, inkl. Schraube / Drehmoment: 35 Ncm / kompatibel mit: Exocad® & 3shape®



 [KLICK ZUM WEBSHOP](#)

	Plattform	NNC	RN	WN
<i>H [mm]</i>		4	4	4
<i>REF</i>	Typ 1	22.270.33.000	22.271.48.000	22.272.65.000
<i>Preis [EUR]</i>		45,-	45,-	45,-

Titanbasen lang, CAD/CAM

Titan Grade 5, unsteril, inkl. Schraube / Drehmoment: 35 Ncm / kompatibel mit: Exocad® & 3shape®

KLICK ZUM
WEBSHOP



	Plattform	NNC	RN	WN
	<i>H [mm]</i>	5,5	5,5	5,5
<i>REF</i>	Typ 1	22.276.33.000	22.277.48.000	22.278.65.000
	<i>Preis [EUR]</i>	45,-	45,-	45,-

Titanbasen nicht indexiert, CAD/CAM

Titan Grade 5, unsteril, inkl. Schraube / Drehmoment: 35 Ncm / ohne Rotationsschutz / kompatibel mit: Exocad® & 3shape®

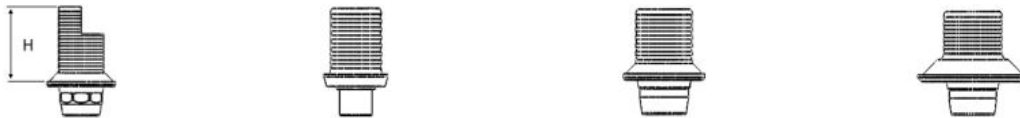

	Plattform	NNC	RN	WN
	<i>H [mm]</i>	4	4	4
<i>REF</i>	Typ 1	22.294.33.000	22.295.48.000	22.296.65.000
	<i>Preis [EUR]</i>	40,-	40,-	40,-

Scanbodys

Titan Grade 4, unsteril, inkl. Schraube / Drehmoment: Handfest



	Plattform	NNC	RN	WN
<i>REF</i>		22.300.33.000	22.301.48.000	22.302.65.000
	<i>Preis [EUR]</i>	30,-	30,-	30,-

Scanbodys sind wieder aufbereitbar und für den intraoralen Einsatz geeignet.

Pre-Mill Abutments

Titan Grade 5, unsteril, inkl. Schraube / Drehmoment: 35 Ncm, kompatibel zum Medentika®-Halter



	Plattform	RN	RN	WN
	<i>∅ [mm]</i>	11,5	15,8	15,8
<i>REF</i>		25.172.11.000	25.174.15.000	25.182.15.000
	<i>Preis [EUR]</i>	37,-	37,-	37,-

Multi-Unit Abutments

Titan Grade 5, unsteril / Drehmoment: 35 Ncm

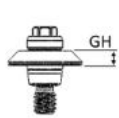

 [Per Klick zum Webshop](#)

Plattform	RN	WN
REF	22.304.48.009	22.305.65.013
Preis [EUR]	49,-	49,-

Multi-Unit Zubehör

Titan Grade 5, unsteril, Anschluss: Torx® T6

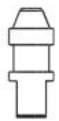

**Titanbasis
Multi-Unit,
CAD/CAM**

**Titankappe
Multi-Unit**

**Gingivaformer
Multi-Unit**

**Scanbody
Multi-Unit**

**Abformpfosten
Multi-Unit
(offene
Abformung)**

**Laboranalog
Multi-Unit**

Material	Titan Grade 5	Titan Grade 5	Titan Grade 5	Titan Grade 4	Titan Grade 5	Titan Grade 5
inkl. Schraube	ja	ja	nein	ja	ja	nein
Drehmoment	15 Ncm	15 Ncm	Handfest	Handfest	Handfest	-
REF	21.187.42.000	21.185.30.000	21.182.45.037	21.321.00.000	23.032.45.000	24.048.45.100
Preis [EUR]	39,-	39,-	18,-	30,-	26,-	12,-

Abformpfosten kurz (offene Abformung)

Titan Grade 5, unsteril, inkl. Schraube, farbcodiert / Drehmoment: Handfest

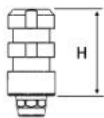

Plattform	RN	WN
H [mm]	9	9
Farbcodierung	rot	grün
REF	23.147.48.000	23.148.65.000
Preis [EUR]	26,-	26,-

Passende Instrumente ab S. 76

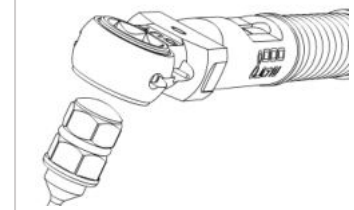

Abformpfosten lang (offene Abformung)

Titan Grade 5, unsteril, inkl. Schraube, farbcodiert / Drehmoment: Handfest

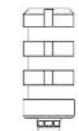
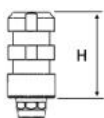

 [Per Klick zum Webshop](#)

Plattform	RN	WN
H [mm]	15	15
Farbcodierung	rot	grün
REF	23.155.48.000	23.156.65.000
Preis [EUR]	26,-	26,-

Abformpfosten (geschlossene Abformung)

Titan Grade 5, unsteril, inkl. Schraube and Kappe, farbcodiert / Drehmoment: Handfest

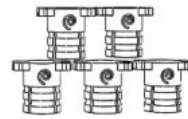

Plattform	RN	WN	Reponierkappen 5 Stk.
H [mm]	10,5	10,5	
Farbcodierung	rot	grün	transparent
REF	23.268.48.011	23.269.65.011	23.999.48.000
Preis [EUR]	29,-	29,-	12,-

Gingivaformer

Titan Grade 5, unsteril, inkl. Schraube, lasermarkiert / Drehmoment: Handfest

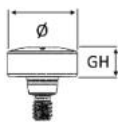

Plattform	RN	RN	RN	WN	WN	WN
GH [mm]	2	3	4	2	3	4
Ø [mm]	5,5	5,5	5,5	7,2	7,2	7,2
REF	22.578.48.020	22.579.48.030	22.580.48.040	22.581.65.020	22.582.65.030	22.583.65.040
Preis [EUR]	18,-	18,-	18,-	18,-	18,-	18,-

[KLICK ZUM WEBSHOP](#)

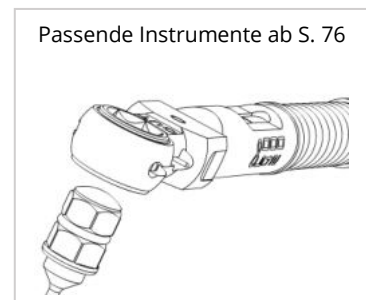
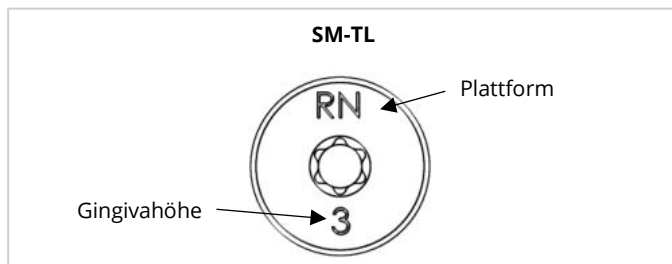

CL-SR Serie - kompatibel zu Camlog® - Screw-Line / Root-Line2®

CL-SR Serie - kompatibel zu **Camlog® - Screw-Line / Root-Line2®**

 **heliocos**
compatible to
Camlog®

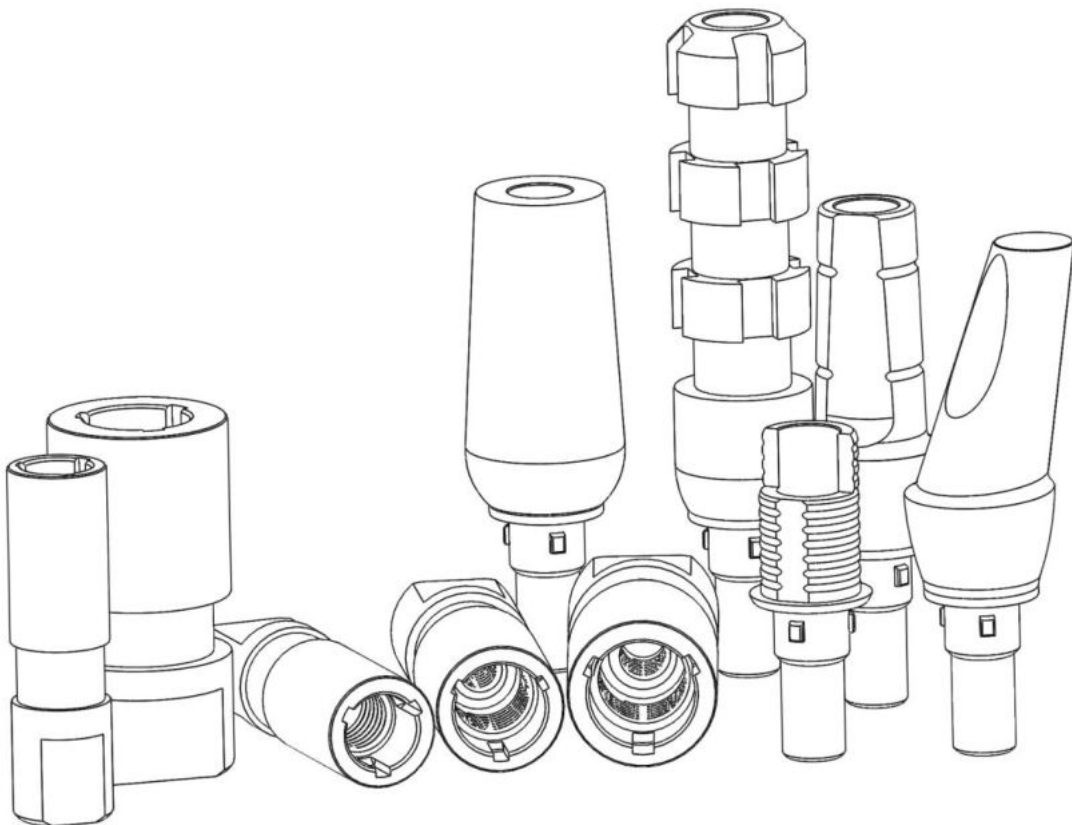

Abutmentschrauben

Titan Grade 5, unsteril, Anschluss: Hex 1,26



Plattform	3,3 / 3,8 / 4,3	5,0 / 6,0	Multi-Unit
Größe	M 1,6	M2	M 1,4
REF	21.430.16.105	21.431.20.105	21.094.21.035
Preis [EUR]	10,-	10,-	10,-

Laborschrauben

Titan Grade 5, unsteril, Anschluss: Hex 1,26, farbcodiert gelb



[KLICK ZUM WEBSHOP](#)

Plattform	3,3 / 3,8 / 4,3	5,0 / 6,0	Multi-Unit
Größe	M 1,6	M2	M 1,4
REF	24.061.16.105	24.062.20.105	24.107.21.035
Preis [EUR]	6	6	6
ab 5 Stk.	4	4	4
ab 10 Stk.	3,5	3,5	3,5

Laboranaloge

Titan Grade 5, unsteril, farbcodiert, für 3D Druck geeignet

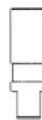
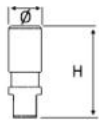

[KLICK ZUM WEBSHOP](#)

Plattform	3,3	3,8	4,3	5,0 / 6,0
H [mm]	12	12	12	12
Ø [mm]	3,3	3,8	4,3	5,0
Farbcodierung	keine	gelb	rot	blau
REF	24.056.33.010	24.057.38.010	24.058.43.010	24.059.50.010
Preis [EUR]	12,-	12,-	12,-	12,-
ab 10 Stk.	9,-	9,-	9,-	9,-
ab 30 Stk.	8,-	8,-	8,-	8,-

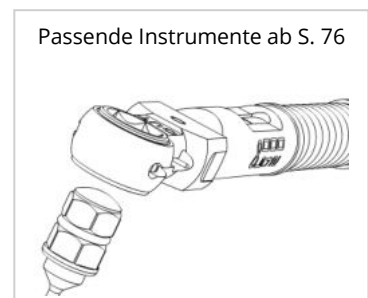
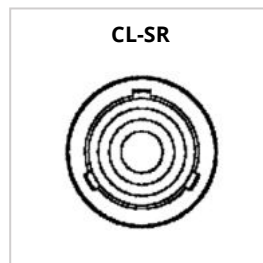

Gerade Abutments

Titan Grade 5, unsteril, inkl. Schraube / Drehmoment: 20 Ncm

[KLICK ZUM WEBSHOP](#)

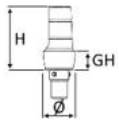

Plattform	3,8	3,8	4,3	4,3	5,0	5,0
GH [mm]	1,5	3,5	1,5	3,5	1,5	3,5
H [mm]	9	11,7	9	11,7	9	11,7
Ø [mm]	4,7	4,7	5,3	5,3	5,8	5,8
REF	21.458.38.000	21.459.38.000	21.460.43.000	21.461.43.000	21.462.50.000	21.463.50.000
Preis [EUR]	60,-	60,-	60,-	60,-	60,-	60,-

Gewinkelte Abutments

Titan Grade 5, unsteril, inkl. Schraube / Drehmoment: 20 Ncm

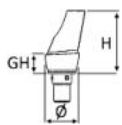

Plattform	3,8	3,8	4,3	4,3
GH [mm]	1,5	3,5	1,5	3,5
H [mm]	9	11,7	9	11,7
Ø [mm]	5	5	5,5	5,5
REF Typ A (17°)	21.474.38.000	21.475.38.000	21.476.43.000	21.477.43.000
Preis [EUR]	75,-	75,-	75,-	75,-

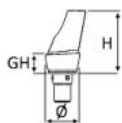

[Per Klick zum Webshop](#)

Plattform	5,0	5,0
GH [mm]	1,5	3,5
H [mm]	9	11,7
Ø [mm]	6,2	6,2
REF Typ A (17°)	21.478.50.000	21.479.50.000
Preis [EUR]	75,-	75,-

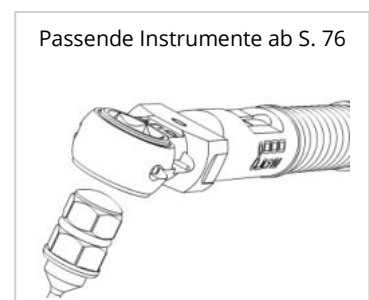

Massivabutments

Titan Grade 5, unsteril, inkl. 2 Schrauben / Drehmoment: 20 Ncm

[KLICK ZUM WEBSHOP](#)



Plattform	3,8	4,3	5,0
H [mm]	11	11	11
Ø [mm]	5,3	5,8	6,5
REF	21.504.38.000	21.505.43.000	21.506.50.000
Preis [EUR]	60,-	60,-	60,-

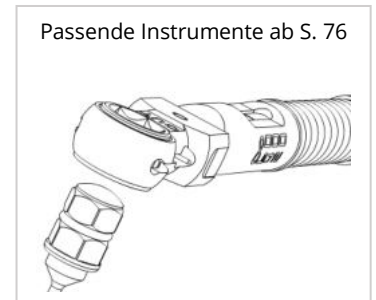

Titanbasen kurz, CAD/CAM

Titan Grade 5, unsteril, inkl. Schraube / Drehmoment: 20 Ncm / kompatibel mit: Exocad® & 3shape®



Plattform	3,3	3,8	4,3	5,0	6,0
GH [mm]	0,3	0,3	0,3	0,3	0,3
H [mm]	4	4	4	4	4
Ø [mm]	3,7	4,1	4,7	5,4	6,4
REF Typ B	21.523.33.000	21.524.38.000	21.525.43.000	21.526.50.000	21.527.60.000
Preis [EUR]	45,-	45,-	45,-	45,-	45,-

Titanbasen lang, CAD/CAM

Titan Grade 5, unsteril, inkl. Schraube / Drehmoment: 20 Ncm / kompatibel mit: Exocad® & 3shape®



Plattform	3,3	3,8	4,3	5,0	6,0
GH [mm]	0,3	0,3	0,3	0,3	0,3
H [mm]	5,5	5,5	5,5	5,5	5,5
Ø [mm]	3,7	4,1	4,7	5,4	6,4
REF Typ B	21.533.33.000	21.534.38.000	21.535.43.000	21.536.50.000	21.537.60.000
Preis [EUR]	45,-	45,-	45,-	45,-	45,-

Titanbasen nicht indexiert, CAD/CAM

Titan Grade 5, unsteril, inkl. Schraube / Drehmoment: 20 Ncm / ohne Rotationsschutz / kompatibel mit: Exocad® & 3shape®



[Per Klick zum Webshop](#)

Plattform	3,3	3,8	4,3	5,0
GH [mm]	0,3	0,3	0,3	0,3
H [mm]	4	4	4	4
Ø [mm]	3,7	4,1	4,7	5,4
REF	21.543.33.000	21.544.38.000	21.545.43.000	21.546.50.000
Preis [EUR]	40,-	40,-	40,-	40,-

Scanbodys

Titan Grade 4, unsteril, inkl. Schraube / Drehmoment: Handfest



Scanbodys sind wieder
aufbereitbar und für
den intraoralen
Einsatz geeignet.

Plattform	3,3	3,8	4,3	5,0 / 6,0
REF	21.552.33.000	21.553.38.000	21.554.43.000	21.555.50.000
Preis [EUR]	30,-	30,-	30,-	30,-

Pre-Mill Abutments

Titan Grade 5, unsteril, inkl. Schraube / Drehmoment: 20 Ncm, kompatibel zum Medentika®-Halter



Plattform	3,3	3,8	4,3	5,0 / 6,0
Ø [mm]	11,5	11,5	15,8	15,8
REF	25.065.11.000	25.073.11.000	25.083.15.000	25.091.15.000
Preis [EUR]	37,-	37,-	37,-	37,-

Multi-Unit Abutments 3,8

Titan Grade 5, unsteril / Drehmoment: 30 Ncm



Per Klick zum Webshop

Plattform	3,8	3,8	3,8
GH [mm]	0,5	2,0	4,0
REF	21.558.38.005	21.559.38.020	21.560.38.040
Preis [EUR]	49,-	49,-	49,-

Multi-Unit Abutments 4,3 / 5,0

Titan Grade 5, unsteril / Drehmoment: 30 Ncm



Plattform	4,3	4,3	4,3	5,0	5,0	5,0
GH [mm]	0,5	2,0	4,0	0,5	2,0	4,0
REF	21.561.43.005	21.562.43.020	21.563.43.040	21.564.50.005	21.565.50.020	21.566.50.040
Preis [EUR]	49,-	49,-	49,-	49,-	49,-	49,-

Multi-Unit Zubehör

Titan Grade 5, unsteril, Anschluss: Hex 1,26

KLICK ZUM WEBSHOP

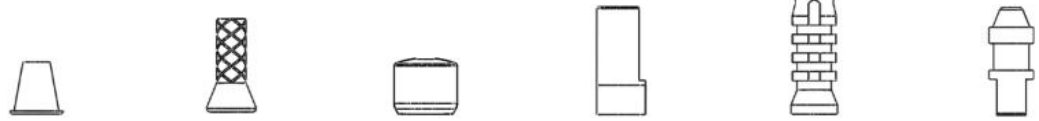

Titanbasis Multi-Unit, CAD/CAM **Titankappe Multi-Unit** **Gingivaformer Multi-Unit** **Scanbody Multi-Unit** **Abformpfosten Multi-Unit (offene Abformung)** **Laboranalog Multi-Unit**

<i>Material inkl. Schraube</i>	Titan Grade 5	Titan Grade 5	Titan Grade 5	Titan Grade 4	Titan Grade 5	Titan Grade 5
<i>Drehmoment</i>	15 Ncm	15 Ncm	Handfest	Handfest	Handfest	-
<i>REF</i>	21.098.42.000	21.096.30.000	21.093.45.037	21.182.00.000	23.019.00.000	24.048.45.100
<i>Preis [EUR]</i>	39,-	39,-	18,-	30,-	26,-	12,-

Abformpfosten kurz (offene Abformung)

Titan Grade 5, unsteril, inkl. Schraube, farbcodiert / Drehmoment: Handfest



Plattform	3,3	3,8	4,3	5,0
<i>H [mm]</i>	11	11	11	11
<i>Farbcodierung</i>	keine	gelb	rot	blau
<i>REF</i>	23.058.33.000	23.059.38.000	23.060.43.000	23.061.50.000
<i>Preis [EUR]</i>	26,-	26,-	26,-	26,-

Abformpfosten lang (offene Abformung)

Titan Grade 5, unsteril, inkl. Schraube, farbcodiert / Drehmoment: Handfest

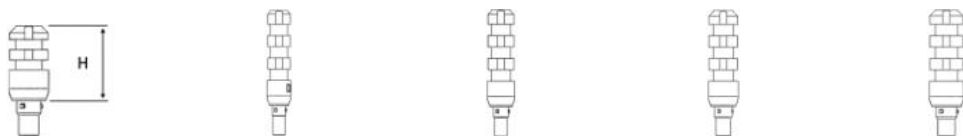

Per Klick zum Webshop

Plattform	3,3	3,8	4,3	5,0
<i>H [mm]</i>	17	17	17	17
<i>Farbcodierung</i>	keine	gelb	rot	blau
<i>REF</i>	23.070.33.000	23.071.38.000	23.072.43.000	23.073.50.000
<i>Preis [EUR]</i>	26,-	26,-	26,-	26,-

Abformpfosten (geschlossene Abformung)

Titan Grade 5, unsteril, inkl. Schraube and Kappe, farbcodiert / Drehmoment: Handfest



Plattform	3,3	3,8	4,3	5,0	Reponierkappen 5 Stk.
<i>H [mm]</i>	10,5	10,5	10,5	10,5	
<i>Farbcodierung</i>	keine	gelb	rot	blau	transparent
<i>REF</i>	23.254.33.011	23.255.38.011	23.256.43.011	23.257.50.011	23.000.48.000
<i>Preis [EUR]</i>	29,-	29,-	29,-	29,-	12,-

Gingivaformer

Titan Grade 5, unsteril, lasermarkiert / Drehmoment: Handfest

**KLICK ZUM
WEBSHOP**

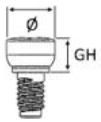

Plattform	3,3	3,3	3,3	3,8	3,8	3,8
GH [mm]	3	4	5	3	4	5
Ø [mm]	4,5	4,5	4,5	4,9	4,9	4,9
REF	21.281.33.030	21.282.33.040	21.283.33.050	21.284.38.030	21.285.38.040	21.286.38.050
Preis [EUR]	18,-	18,-	18,-	18,-	18,-	18,-

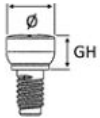

Plattform	4,3	4,3	4,3	5,0	5,0	5,0
GH [mm]	3	4	5	3	4	5
Ø [mm]	5,5	5,5	5,5	6,2	6,2	6,2
REF	21.287.43.030	21.288.43.040	21.289.43.050	21.290.50.030	21.291.50.040	21.292.50.050
Preis [EUR]	18,-	18,-	18,-	18,-	18,-	18,-

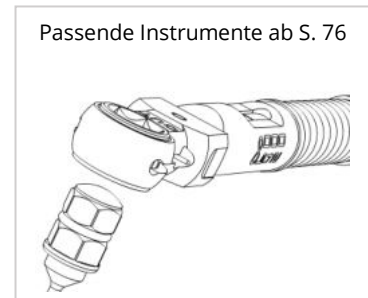
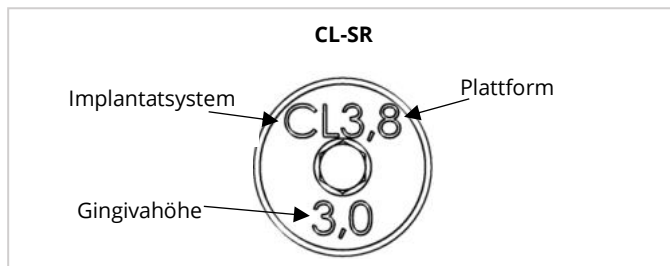

CL-CO Serie - kompatibel zu Camlog® - Conelog®

CL-CO Serie - kompatibel zu **Camlog® - Conelog®**

**helioscos**
compatible to
Conelog®

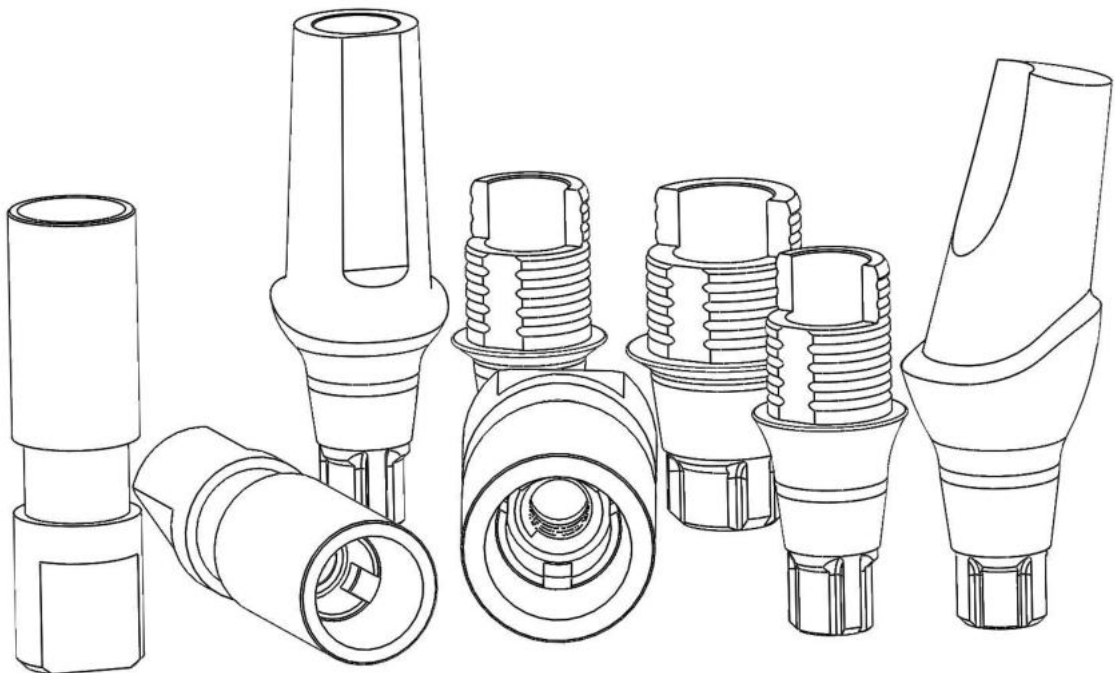

CL-CO Serie - kompatibel zu Camlog® - Conelog®

Abutmentschrauben

Titan Grade 5, unsteril, Anschluss: Hex 1,26



Plattform	3,3 / 3,8 / 4,3	5,0	Multi-Unit
Größe	M 1,6	M2	M 1,4
REF	22.311.16.089	22.312.20.089	21.094.21.035
Preis [EUR]	10,-	10,-	10,-

Laborschrauben

Titan Grade 5, unsteril, Anschluss: Hex 1,26, farbcodiert gelb



[KLICK ZUM WEBSHOP](#)

Plattform	3,3 / 3,8 / 4,3	5,0	Multi-Unit
Größe	M 1,6	M2	M 1,4
REF	24.071.16.089	24.094.20.089	24.107.21.035
Preis [EUR]	6	6	6
ab 5 Stk.	4	4	4
ab 10 Stk.	3,5	3,5	3,5

Laboranaloge

Titan Grade 5, unsteril, farbcodiert, für 3D Druck geeignet

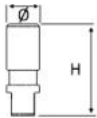

[KLICK ZUM WEBSHOP](#)

Plattform	3,3	3,8	4,3	5,0
H [mm]	12	12	12	12
Ø [mm]	3,3	3,8	4,3	5,0
REF	24.069.33.010	24.070.00.010	24.105.43.120	24.082.50.120
Farbcodierung	keine	gelb	rot	blau
Preis [EUR]	12,-	12,-	12,-	12,-
ab 10 Stk.	9,-	9,-	9,-	9,-
ab 30 Stk.	8,-	8,-	8,-	8,-

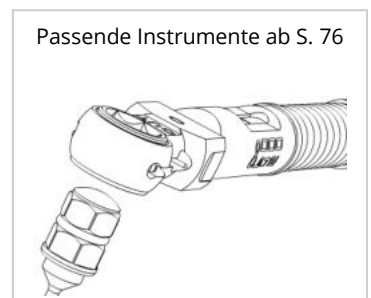
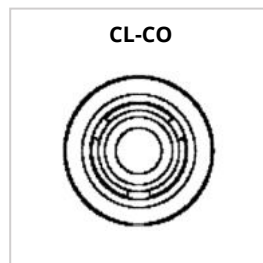

Gerade Abutments

Titan Grade 5, unsteril, inkl. Schraube / Drehmoment: 20 Ncm

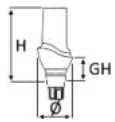

**KLICK ZUM
WEBSHOP**

Plattform	3,8	3,8	4,3	4,3	5,0	5,0
GH [mm]	1,5	3,0	1,5	3,0	1,5	3,0
H [mm]	8	9,5	8	9,5	8	9,5
Ø [mm]	5,4	5,5	5,9	5,9	6,8	6,8
REF	22.337.38.000	22.338.38.000	22.339.43.000	22.340.43.000	22.341.50.000	22.342.50.000
Preis [EUR]	60,-	60,-	60,-	60,-	60,-	60,-

Gewinkelte Abutments

Titan Grade 5, unsteril, inkl. Schraube / Drehmoment: 20 Ncm

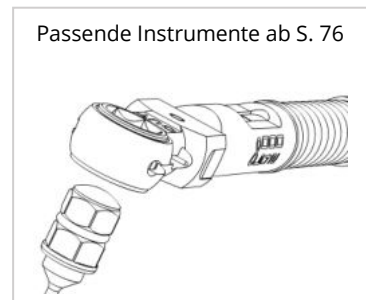
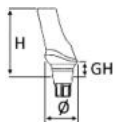

Plattform	3,8/4,3	3,8/4,3
GH [mm]	1,5	3,0
H [mm]	9,5	11
Ø [mm]	5,5	5,3
REF Typ A (17°)	22.349.38.000	22.350.38.000
Preis [EUR]	75,-	75,-



Titanbasen kurz, CAD/CAM

Titan Grade 5, unsteril, inkl. Schraube / Drehmoment: 20 Ncm / kompatibel mit: Exocad® & 3shape®

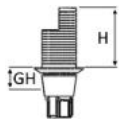

Per Klick zum Webshop

Plattform	3,3	3,8/4,3	5,0
GH [mm]	1	1	1
H [mm]	4	4	4
REF Typ A	22.394.33.000	22.395.00.000	22.396.50.000
Preis [EUR]	45,-	45,-	45,-

Titanbasen lang, CAD/CAM

Titan Grade 5, unsteril, inkl. Schraube / Drehmoment: 20 Ncm / kompatibel mit: Exocad® & 3shape®



Plattform	3,3	3,8/4,3	5,0
GH [mm]	1	1	1
H [mm]	5,5	5,5	5,5
REF Typ A	22.400.33.000	22.401.00.000	22.402.50.000
Preis [EUR]	45,-	45,-	45,-

Passende Instrumente ab S. 76

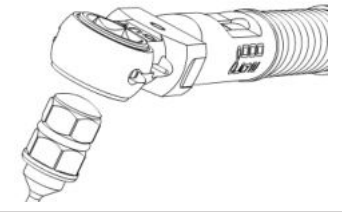

Titanbasen nicht indexiert, CAD/CAM

Titan Grade 5, unsteril, inkl. Schraube / Drehmoment: 20 Ncm / ohne Rotationsschutz / kompatibel mit: Exocad® & 3shape®

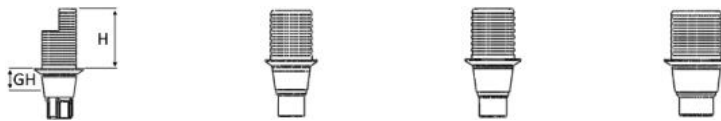

 [Per Klick zum Webshop](#)

Plattform	3,3	3,8/4,3	5,0
GH [mm]	1	1	1
H [mm]	4	4	4
REF	22.418.33.000	22.419.00.000	22.420.50.000
Preis [EUR]	40,-	40,-	40,-

Scanbodys

Titan Grade 4, unsteril, inkl. Schraube / Drehmoment: Handfest



Scanbodys sind wieder aufbereitbar und für den intraoralen Einsatz geeignet.

Plattform	3,3	3,8/4,3	5,0
REF	22.424.33.000	22.425.00.000	22.426.50.000
Preis [EUR]	30,-	30,-	30,-

Pre-Mill Abutments

Titan Grade 5, unsteril, inkl. Schraube / Drehmoment: 20 Ncm, kompatibel zum Medentika®-Halter



Plattform	3,3	3,8 / 4,3	5,0
Ø [mm]	11,5	11,5	15,8
REF	25.188.11.000	25.196.11.000	25.206.15.000
Preis [EUR]	37,-	37,-	37,-

Multi-Unit Abutments

Titan Grade 5, unsteril / Drehmoment: 20 Ncm

 **KLICK ZUM WEBSHOP**



Plattform	3,8 / 4,3	3,8 / 4,3	3,8 / 4,3	5,0	5,0	5,0
GH [mm]	1,0	2,5	4,0	1,0	2,5	4,0
REF	22.429.00.010	22.430.00.025	22.431.00.040	22.432.50.010	22.433.50.025	22.434.50.040
Preis [EUR]	49,-	49,-	49,-	49,-	49,-	49,-

Multi-Unit Zubehör

Titan Grade 5, unsteril, Anschluss: Hex 1,26



Titanbasis Multi-Unit, CAD/CAM **Titankappe Multi-Unit** **Gingivaformer Multi-Unit** **Scanbody Multi-Unit** **Abformpfosten Multi-Unit (offene Abformung)** **Laboranalog Multi-Unit**

Material	Titan Grade 5	Titan Grade 5	Titan Grade 5	Titan Grade 4	Titan Grade 5	Titan Grade 5
inkl. Schraube	ja	ja	nein	ja	ja	nein
Drehmoment	15 Ncm	15 Ncm	Handfest	Handfest	Handfest	-
REF	21.098.42.000	21.096.30.000	21.093.45.037	21.182.00.000	23.019.00.000	24.048.45.100
Preis [EUR]	39,-	39,-	18,-	30,-	26,-	12,-

Abformpfosten kurz (offene Abformung)

Titan Grade 5, unsteril, inkl. Schraube, farbcodiert / Drehmoment: Handfest



 **Per Klick zum Webshop**

Plattform	3,3	3,8	4,3	5,0
H [mm]	11	11	11	11
Farbcodierung	keine	gelb	rot	blau
REF	23.161.33.000	23.162.00.000	23.193.43.000	23.163.50.000
Preis [EUR]	26,-	26,-	26,-	26,-

Abformpfosten lang (offene Abformung)

Titan Grade 5, unsteril, inkl. Schraube, farbcodiert / Drehmoment: Handfest

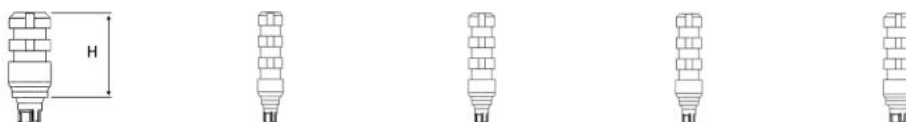

Plattform	3,3	3,8	4,3	5,0
H [mm]	17	17	17	17
Farbcodierung	keine	gelb	rot	blau
REF	23.168.33.000	23.169.00.000	23.195.43.000	23.170.50.000
Preis [EUR]	26,-	26,-	26,-	26,-

Abformpfosten (geschlossene Abformung)

Titan Grade 5, unsteril, inkl. Schraube and Kappe, farbcodiert / Drehmoment: Handfest

[KLICK ZUM WEBSHOP](#)

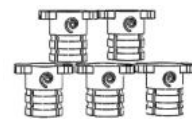
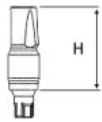

Plattform

3,3

3,8

4,3

5,0

Reponierkappen
5 Stk.

H [mm]	10,5	10,5	10,5	10,5	10,5	
Farbcodierung	keine	gelb	rot	blau	transparent	
REF	23.270.33.011	23.271.38.011	23.272.43.011	23.273.50.011	23.000.48.000	
Preis [EUR]	29,-	29,-	29,-	29,-	12,-	

Gingivaformer

Titan Grade 5, unsteril, lasermarkiert / Drehmoment: Handfest

[KLICK ZUM WEBSHOP](#)

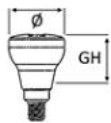

Plattform

3,3

3,3

3,3

3,8

3,8

3,8

GH [mm]	3	4	5	3	4	5
Ø [mm]	3,9	3,9	3,9	4,5	4,5	4,5
REF	22.774.33.030	22.775.33.040	22.776.33.050	22.777.38.030	22.778.38.040	22.779.38.050
Preis [EUR]	18,-	18,-	18,-	18,-	18,-	18,-

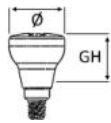

Plattform

4,3

4,3

4,3

5,0

5,0

5,0

GH [mm]	3	4	5	3	4	5
Ø [mm]	5,0	5,0	5,0	5,7	5,7	5,7
REF	22.780.43.030	22.781.43.040	22.782.43.050	22.783.50.030	22.784.50.040	22.785.50.050
Preis [EUR]	18,-	18,-	18,-	18,-	18,-	18,-

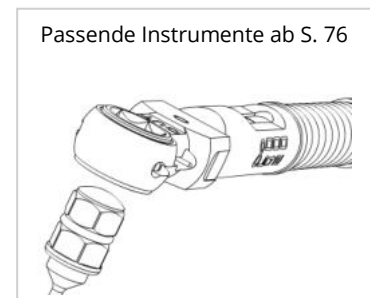
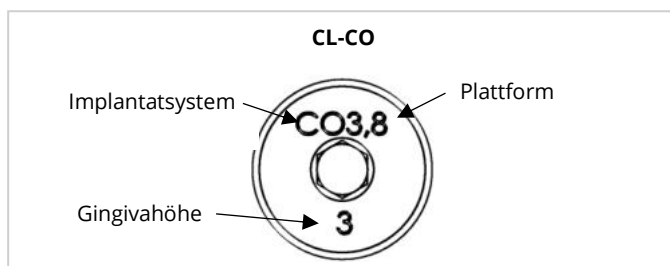

AT-TX Serie - kompatibel zu Dentsply® - Astra Tech® OsseoSpeed® TX

AT-TX Serie - kompatibel zu **Dentsply® - Astra Tech®
OsseoSpeed® TX**

 **heliocos**
compatible to
Astra Tech®

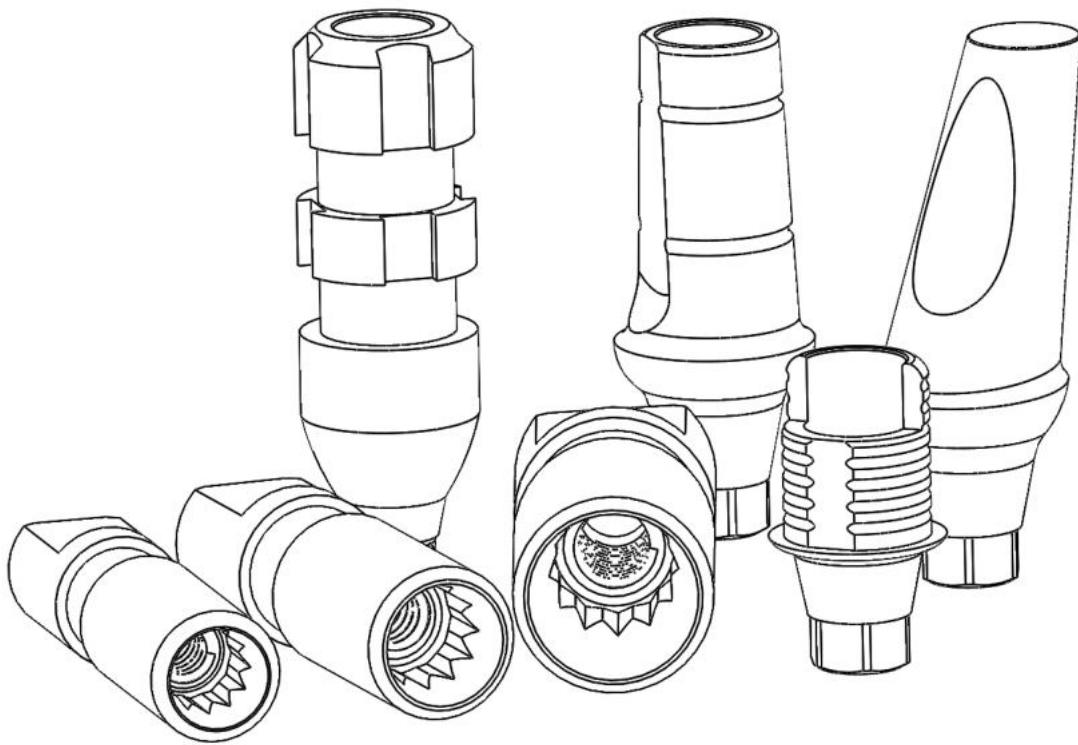

Abutmentschrauben

Titan Grade 5, unsteril, Anschluss: Hex 1,26



Plattform	3,0	3,5 / 4,0	4,5 / 5,0	Multi-Unit
Größe	M1,4	M1,6	M2	M1,4
REF	21.339.30.014	21.340.00.016	21.341.00.020	21.094.21.035
Preis [EUR]	10,-	10,-	10,-	10,-

Laborschrauben

Titan Grade 5, unsteril, Anschluss: Hex 1,26, farbcodiert gelb



Plattform	3,0	3,5 / 4,0	4,5 / 5,0	Multi-Unit
Größe	M1,4	M1,6	M2	M1,4
REF	24.017.30.075	24.018.00.080	24.019.00.095	24.107.21.035
Preis [EUR]	6,-	6,-	6,-	6,-
ab 5 Stk.	4,-	4,-	4,-	4,-
ab 10 Stk.	3,50	3,50	3,50	3,50

Laboranaloge

Titan Grade 5, unsteril, farbcodiert, für 3D Druck geeignet

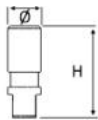

**KLICK ZUM
WEBSHOP**

Plattform	3,0	3,5 / 4,0	4,5 / 5,0
H [mm]	12	12	12
Ø [mm]	3,0	3,5	4,5
Farbcodierung	gelb	türkis	lila
REF	24.014.30.010	24.015.00.010	24.016.00.010
Preis [EUR]	12,-	12,-	12,-
Ab 10 Stk.	9,-	9,-	9,-
Ab 30 Stk.	8,-	8,-	8,-

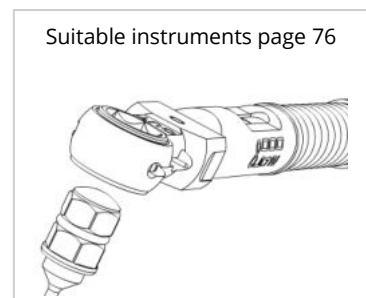
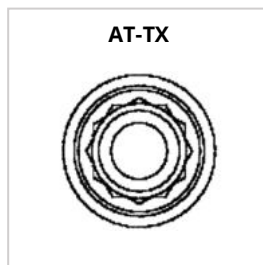

Gerade Abutments

Titan Grade 5, unsteril, inkl. Schraube

3,0: Drehmoment: 15 Ncm

3,5/4,0 und 4,5/5,0: Drehmoment: 25 Ncm

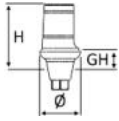

**KLICK ZUM
WEBSHOP**



Plattform	3,0	3,0	3,5 / 4,0	3,5 / 4,0
GH [mm]	1,5	2,5	2	4
H [mm]	7	8	9	10
Ø [mm]	4	4	4,5	4,5
REF	21.360.30.000	21.361.30.000	21.362.00.000	21.364.00.000
Preis [EUR]	60,-	60,-	60,-	60,-

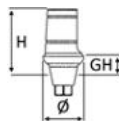

Plattform	4,5 / 5,0	4,5 / 5,0
GH [mm]	2	4
H [mm]	9	10
Ø [mm]	6	6
REF	21.366.00.000	21.367.00.000
Preis [EUR]	60,-	60,-

Passende Instrumente ab S. 76

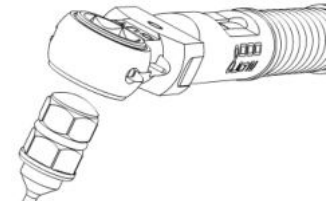

Gewinkelte Abutments

Titan Grade 5, unsteril, inkl. Schraube

3,0: Drehmoment: 15 Ncm

3,5/4,0 und 4,5/5,0: Drehmoment: 25 Ncm

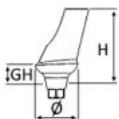

15°



20°



20°



20°



Per Klick zum Webshop

Plattform	3,0	3,5 / 4,0	3,5 / 4,0	4,5 / 5,0
GH [mm]	2,5	2	2	2
H [mm]	7,5	9,5	9,5	9,5
Ø [mm]	4	4,5	5,5	6
REF	21.372.30.000	21.373.00.000	21.374.00.000	21.375.00.000
Preis [EUR]	75,-	75,-	75,-	75,-

Titanbasen kurz, CAD/CAM

Titan Grade 5, unsteril, inkl. Schraube / kompatibel mit: Exocad® & 3shape®

3,0: Drehmoment: 15 Ncm

3,5/4,0 und 4,5/5,0: Drehmoment: 25 Ncm

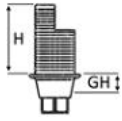

[KLICK ZUM WEBSHOP](#)

Plattform	3,0	3,5 / 4,0	4,5 / 5,0
GH [mm]	0,6	0,6	0,6
H [mm]	4	4	4
REF	21.387.30.000	21.388.00.000	21.389.00.000
Preis [EUR]	45,-	45,-	45,-

Titanbasen lang, CAD/CAM

Titan Grade 5, unsteril, inkl. Schraube / kompatibel mit: Exocad® & 3shape®

3,0: Drehmoment: 15 Ncm

3,5/4,0 und 4,5/5,0: Drehmoment: 25 Ncm

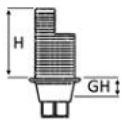

Plattform	3,0	3,5 / 4,0	4,5 / 5,0
GH [mm]	0,6	0,6	0,6
H [mm]	5,5	5,5	5,5
REF	21.393.30.000	21.394.00.000	21.395.00.000
Preis [EUR]	45,-	45,-	45,-

Titanbasen nicht indexiert, CAD/CAM

Titan Grade 5, unsteril, inkl. Schraube / Drehmoment: 25 Ncm / ohne Rotationsschutz / kompatibel mit: Exocad® & 3shape®

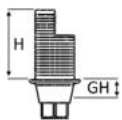

[Per Klick zum Webshop](#)

Plattform	3,5 / 4,0	4,5 / 5,0
GH [mm]	0,6	0,6
H [mm]	4	4
REF	21.398.00.000	21.399.00.000
Preis [EUR]	40,-	40,-

Passende Instrumente ab S. 76

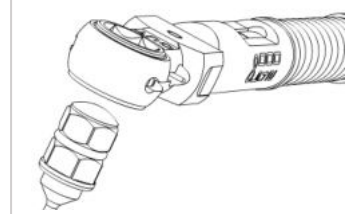

Scanbodys

Titan Grade 4, unsteril, inkl. Schraube / Drehmoment: Handfest



Scanbodys sind wieder aufbereitbar und für den intraoralen Einsatz geeignet.

Plattform	3,0	3,5 / 4,0	4,5 / 5,0
REF	21.403.30.000	21.404.00.000	21.405.00.000
Preis [EUR]	30,-	30,-	30,-

Pre-Mill Abutments

Titan Grade 5, unsteril, inkl. Schraube / Drehmoment: 25 Ncm, kompatibel zum Medentika®-Halter



Plattform	3,5 / 4,0	4,5 / 5,0
Ø [mm]	11,5	15,8
REF	25.049.11.000	25.059.15.000
Preis [EUR]	37,-	37,-

Multi-Unit Abutments D3,5 / 4,0

Titan Grade 5, unsteril / Drehmoment: 25 Ncm

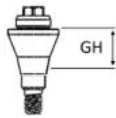

[KLICK ZUM WEBSHOP](#)

Plattform	3,5 / 4,0	3,5 / 4,0	3,5 / 4,0	3,5 / 4,0
GH [mm]	1,5	2,5	3,5	4,5
REF	21.407.00.015	21.408.00.025	21.409.00.035	21.410.00.045
Preis [EUR]	49,-	49,-	49,-	49,-

Multi-Unit Abutments D4,5 / 5,0

Titan Grade 5, unsteril / Drehmoment: 25 Ncm

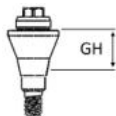

[Per Klick zum Webshop](#)

Plattform	4,5 / 5,0	4,5 / 5,0	4,5 / 5,0	4,5 / 5,0
GH [mm]	1,5	2,5	3,5	4,5
REF	21.412.00.015	21.413.00.025	21.414.00.035	21.415.00.045
Preis [EUR]	49,-	49,-	49,-	49,-

Passende Instrumente ab S. 76

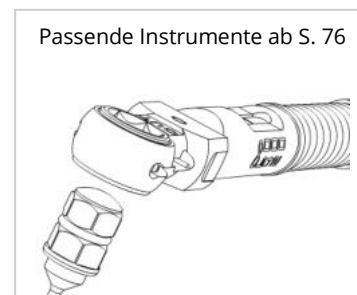

Multi-Unit Zubehör

Titan Grade 5, unsteril, Anschluss: Hex 1,26

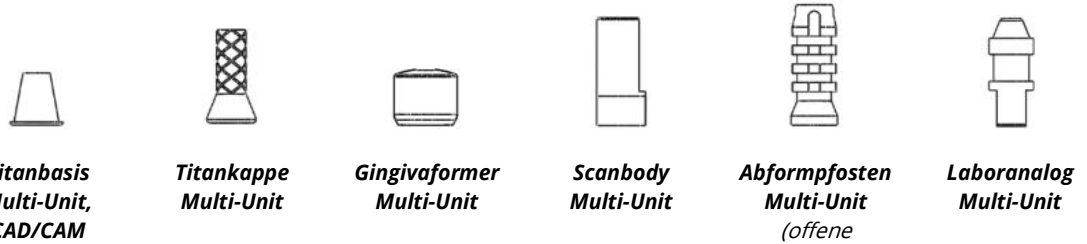

	Titanbasis Multi-Unit, CAD/CAM	Titankappe Multi-Unit	Gingivaformer Multi-Unit	Scanbody Multi-Unit	Abformpfosten Multi-Unit (offene Abformung)	Laboranalog Multi-Unit
Material	Titan Grade 5	Titan Grade 5	Titan Grade 5	Titan Grade 4	Titan Grade 5	Titan Grade 5
inkl. Schraube	ja	ja	nein	ja	ja	nein
Drehmoment	15 Ncm	15 Ncm	Handfest	Handfest	Handfest	-
REF	21.098.42.000	21.096.30.000	21.093.45.037	21.182.00.000	23.019.00.000	24.048.45.100
Preis [EUR]	39,-	39,-	18,-	30,-	26,-	12,-

Abformpfosten kurz (offene Abformung)

Titan Grade 5, unsteril, inkl. Schraube, farbcodiert / Drehmoment: Handfest



	3,0	3,5 / 4,0	4,5 / 5,0
Plattform	3,0	3,5 / 4,0	4,5 / 5,0
H [mm]	11	11	11
Farbcodierung	gelb	türkis	lila
REF	23.039.30.000	23.040.00.000	23.041.00.000
Preis [EUR]	26,-	26,-	26,-

Abformpfosten lang (offene Abformung)

Titan Grade 5, unsteril, inkl. Schraube, farbcodiert / Drehmoment: Handfest



	3,0	3,5 / 4,0	4,5 / 5,0
Plattform	3,0	3,5 / 4,0	4,5 / 5,0
H [mm]	16,5	16,5	16,5
Farbcodierung	gelb	türkis	lila
REF	23.048.30.000	23.049.00.000	23.050.00.000
Preis [EUR]	26,-	26,-	26,-

Abformpfosten (geschlossene Abformung)

Titan Grade 5, unsteril, inkl. Schraube, farbcodiert / Drehmoment: Handfest

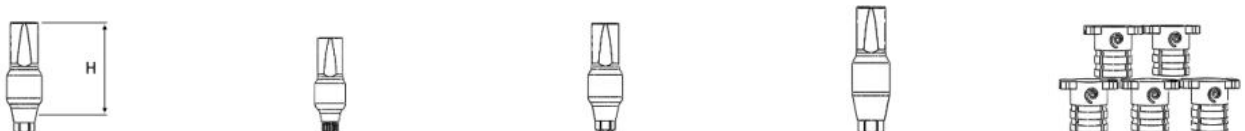

	3,0	3,5 / 4,0	4,5 / 5,0	Reponierkappen 5 Stk.
Plattform	3,0	3,5 / 4,0	4,5 / 5,0	Reponierkappen 5 Stk.
H [mm]	10,5	10,5	10,5	
Farbcodierung	gelb	türkis	lila	transparent
REF	23.251.30.011	23.252.35.011	23.253.45.011	23.999.48.000
Price [EUR]:	29,-	29,-	29,-	12,-

Gingivaformer

Titan Grade 5, unsteril, inkl. Schraube, lasermarkiert / Drehmoment: Handfest

KLICK ZUM WEBSHOP

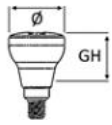

Plattform	3,0	3,0	3,0
GH [mm]	3	4	5
Ø [mm]	4	4	4
REF	22.600.30.030	22.601.30.040	22.602.30.050
Preis [EUR]	18,-	18,-	18,-

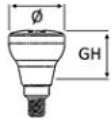

Plattform	3,5 / 4,0	3,5 / 4,0	3,5 / 4,0
GH [mm]	3	4	5
Ø [mm]	4,5	4,5	4,5
REF	22.603.35.030	22.604.35.040	22.605.35.050
Preis [EUR]	18,-	18,-	18,-

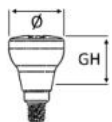

Plattform	4,5 / 5,0	4,5 / 5,0	4,5 / 5,0
GH [mm]	3	4	5
Ø [mm]	5	5	5
REF	22.606.45.030	22.607.45.040	22.608.45.050
Preis [EUR]	18,-	18,-	18,-

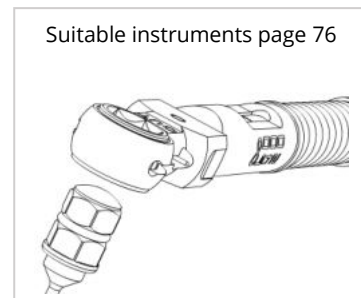
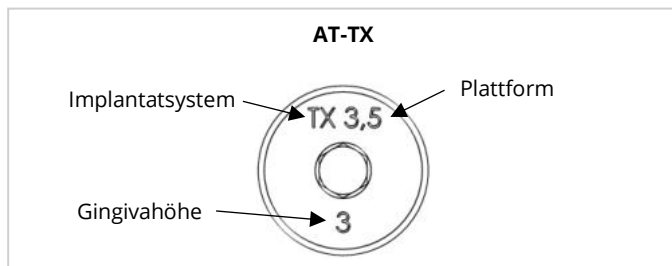

AT-EV Serie - kompatibel zu Dentsply® - Astra Tech® EV™

AT-EV Serie - kompatibel zu **Dentsply® - Astra Tech® EV™**

 **heliocos**
compatible to
Astra Tech® EV™

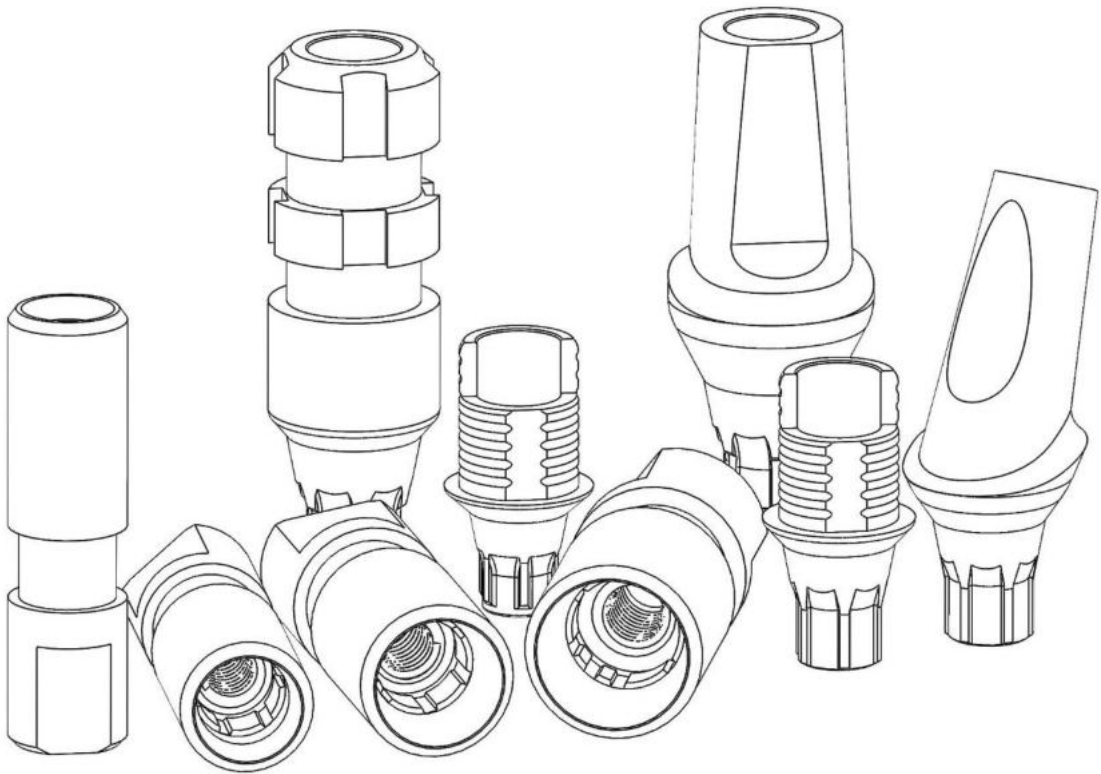

Abutmentschrauben

Titan Grade 5, unsteril, Anschluss: Hex 1,26



Plattform	3,0	3,6	4,2	4,8/5,4	Multi-Unit
Größe	M1,4	M1,6	M1,8	M2	M1,4
REF	22.435.14.076	22.436.16.075	22.437.18.076	22.438.20.076	21.094.21.035
Preis [EUR]	10,-	10	10	10	10

Laborschrauben

Titan Grade 5, unsteril, Anschluss: Hex 1,26, farbcodiert gelb



Plattform	3,0	3,6	4,2	4,8/5,4	Multi-Unit
Größe	M1,4	M1,6	M1,8	M2	M1,4
REF	24.096.14.076	24.097.16.075	24.098.18.076	24.099.20.076	24.107.21.035
Preis [EUR]	6,-	6,-	6,-	6,-	6,-
ab 5 Stk.	4,-	4,-	4,-	4,-	4,-
Ab 10 Stk.	3,50	3,50	3,50	3,50	3,50

Laboranaloge

Titan Grade 5, unsteril, farbcodiert, für 3D Druck geeignet



Plattform	3,0	3,6	4,2	4,8	5,4
H [mm]	12	12	12	12	12
REF	24.083.30.120	24.084.36.120	24.085.42.120	24.086.48.120	24.087.54.120
Farbcodierung	grün	lila	gelb	blau	braun
Preis [EUR]	12,-	12,-	12,-	12,-	12,-
ab 10 Stk.	9,-	9,-	9,-	9,-	9,-
Ab 30 Stk.	8,-	8,-	8,-	8,-	8,-

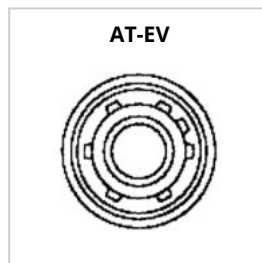

Gerade Abutments

Titan Grade 5, unsteril, inkl. Schraube / Drehmoment: 25 Ncm

[KLICK ZUM WEBSHOP](#)

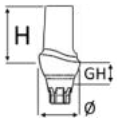

Plattform	3,0	3,0	3,6	4,2
GH [mm]	1,5	2,5	2,5	2,5
H [mm]	7	8	10	10
Ø [mm]	4	4	4,5	5,5
REF	22.476.30.000	22.477.36.000	22.478.36.000	22.479.42.000
Preis [EUR]	60,-	60,-	60,-	60,-

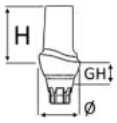

Plattform	4,8	5,4	5,4
GH [mm]	2,5	1,5	2,5
H [mm]	10	9	10
Ø [mm]	7,0	7,0	7,0
REF	22.480.48.000	22.481.54.000	22.482.54.000
Preis [EUR]	60,-	60,-	60,-

Gewinkelte Abutments

Titan Grade 5, unsteril, inkl. Schraube / Drehmoment: 25 Ncm

[KLICK ZUM WEBSHOP](#)



Plattform	3,6	4,2	4,8
GH [mm]	1,5	1,5	1,5
H [mm]	9	9	9
Ø [mm]	4,5	5,5	5,5
REF (20°)	22.488.36.000	22.489.42.000	22.490.48.000
Preis [EUR]	75,-	75,-	75,-

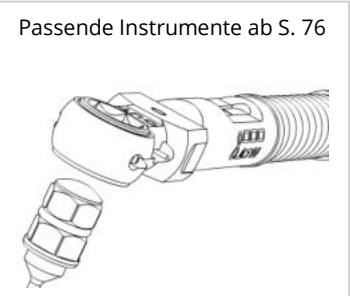

Titanbasen kurz, CAD/CAM

Titan Grade 5, unsteril, inkl. Schraube / Drehmoment: 25 Ncm / kompatibel mit: Exocad® & 3shape®

KLICK ZUM
WEBSHOP

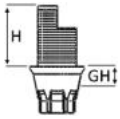

Plattform	3,0	3,6	4,2	4,8	5,4
GH [mm]	1,0	1,0	1,0	1,0	1,0
H [mm]	4	4	4	4	4
REF	22.514.30.000	22.515.36.000	22.516.42.000	22.517.48.000	22.518.54.000
Preis [EUR]	45,-	45,-	45,-	45,-	45,-

Titanbasen lang, CAD/CAM

Titan Grade 5, unsteril, inkl. Schraube / Drehmoment: 25 Ncm / kompatibel mit: Exocad® & 3shape®



Plattform	3,0	3,6	4,2	4,8	5,4
GH [mm]	1,0	1,0	1,0	1,0	1,0
H [mm]	5,5	5,5	5,5	5,5	5,5
REF	22.524.30.000	22.525.36.000	22.526.42.000	22.527.48.000	22.528.54.000
Preis [EUR]	45,-	45,-	45,-	45,-	45,-

Titanbasen nicht indexiert, CAD/CAM

Titan Grade 5, unsteril, inkl. Schraube / Drehmoment: 25 Ncm / ohne Rotationsschutz / kompatibel mit: Exocad® & 3shape®

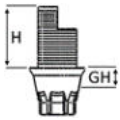

Plattform	3,0	3,6	4,2	4,8	5,4
GH [mm]	1,0	1,0	1,0	1,0	1,0
H [mm]	4	4	4	4	4
REF	22.534.30.000	22.535.36.000	22.536.42.000	22.537.48.000	22.538.54.000
Preis [EUR]	40,-	40,-	40,-	40,-	40,-

Passende Instrumente ab S. 76

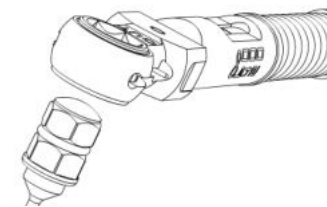

Scanbodys

Titan Grade 4, unsteril, inkl. Schraube / Drehmoment: Handfest

[KLICK ZUM WEBSHOP](#)

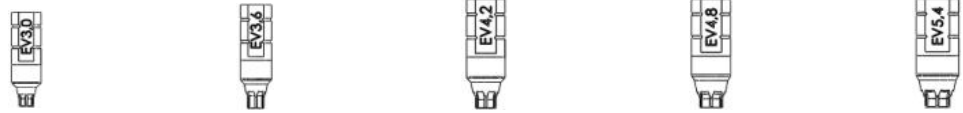

Plattform	3,0	3,6	4,2	4,8	5,4
REF	22.544.30.000	22.545.36.000	22.546.42.000	22.547.48.000	22.548.54.000
Preis [EUR]	30,-	30,-	30,-	30,-	30,-

Pre-Mill Abutments

Titan Grade 5, unsteril, inkl. Schraube / Drehmoment: 25 Ncm, kompatibel zum Medentika®-Halter



Plattform	3,6	4,2	4,8
∅ [mm]	11,5	11,5	15,8
REF	25.216.11.000	25.224.11.000	25.234.15.000
Preis [EUR]	37,-	37,-	37,-

Multi-Unit Abutments D3,6

Titan Grade 5, unsteril / Drehmoment: 25 Ncm

[KLICK ZUM WEBSHOP](#)



Plattform	3,6	3,6	3,6	3,6
GH [mm]	1	2	3	5
REF	22.553.36.010	22.554.36.020	22.555.36.030	22.556.36.050
Preis [EUR]	49,-	49,-	49,-	49,-

Multi-Unit Abutments D4,2

Titan Grade 5, unsteril / Drehmoment: 25 Ncm



Plattform	4,2	4,2	4,2	4,2
GH [mm]	1	2	3	5
REF	22.557.42.010	22.558.42.020	22.559.42.030	22.560.42.050
Preis [EUR]	49,-	49,-	49,-	49,-

Multi-Unit Abutments D4,8

Titan Grade 5, unsteril / Drehmoment: 25 Ncm



Plattform	4,8	4,8	4,8	4,8
GH [mm]	1	2	3	5
REF	22.561.48.010	22.562.48.020	22.563.48.030	22.564.48.050

Preis [EUR] | 49,- 49,- 49,- 49,-

Multi-Unit Zubehör

Titan Grade 5, unsteril, Anschluss: Hex 1,26

KLICK ZUM WEBSHOP



Titanbasis Multi-Unit, CAD/CAM **Titankappe Multi-Unit** **Gingivaformer Multi-Unit** **Scanbody Multi-Unit** **Abformpfosten Multi-Unit (offene Abformung)** **Laboranalog Multi-Unit**

<i>Material</i>	Titan Grade 5	Titan Grade 5	Titan Grade 5	Titan Grade 4	Titan Grade 5	Titan Grade 5
<i>inkl. Schraube</i>	ja	ja	nein	ja	ja	nein
<i>Drehmoment</i>	15 Ncm	15 Ncm	Handfest	Handfest	Handfest	-
<i>REF</i>	21.098.42.000	21.096.30.000	21.093.45.037	21.182.00.000	23.019.00.000	24.048.45.100
<i>Preis [EUR]</i>	39,-	39,-	18,-	30,-	26,-	12,-

Abformpfosten kurz (offene Abformung)

Titan Grade 5, unsteril, inkl. Schraube, farbcodiert / Drehmoment: Handfest



Plattform	3,0	3,6	4,2	4,8	5,4
<i>H [mm]</i>	11	11	11	11	11
<i>Farbcodierung</i>	grün	lila	gelb	blau	braun
<i>REF</i>	23.196.30.000	23.197.36.000	23.198.42.000	23.199.48.000	23.200.54.000
<i>Preis [EUR]</i>	26,-	26,-	26,-	26,-	26,-

Abformpfosten lang (offene Abformung)

Titan Grade 5, unsteril, inkl. Schraube, farbcodiert / Drehmoment: Handfest

KLICK ZUM WEBSHOP



Plattform	3,0	3,6	4,2	4,8	5,4
<i>H [mm]</i>	17	17	17	17	17
<i>Farbcodierung</i>	grün	lila	gelb	blau	braun
<i>REF</i>	23.210.30.000	23.211.36.000	23.212.42.000	23.213.48.000	23.214.54.000
<i>Preis [EUR]</i>	26,-	26,-	26,-	26,-	26,-

Abformpfosten (geschlossene Abformung)

Titan Grade 5, unsteril, inkl. Schraube and Kappe, farbcodiert / Drehmoment: Handfest

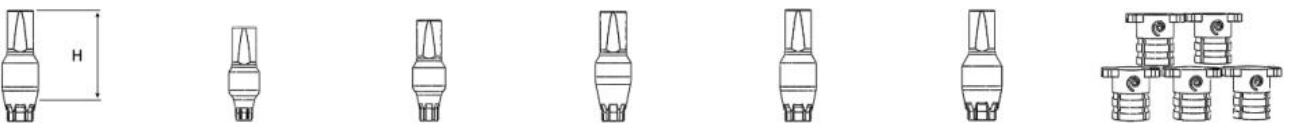

Plattform	3,0	3,6	4,2	4,8	5,4	Reponierkappen 5 Stk.
<i>H [mm]</i>	10,5	10,5	10,5	10,5	10,5	
<i>Farbcodierung</i>	grün	lila	gelb	blau	braun	Transparent
<i>REF</i>	23.274.30.011	23.275.36.011	23.276.42.011	23.277.48.011	23.278.54.011	23.999.48.000
<i>Preis [EUR]</i>	29,-	29,-	29,-	29,-	29,-	12,-

Gingivaformer

Titan Grade 5, unsteril, inkl. Schraube, lasermarkiert / Drehmoment: Handfest

[KLICK ZUM WEBSHOP](#)

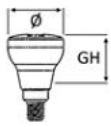

Plattform	3,0	3,0	3,0	3,6	3,6	3,6
GH [mm]	3,5	4,5	6,5	3,5	4,5	6,5
Ø [mm]	4,0	4,0	4,0	4,5	4,5	4,5
REF	22.755.30.035	22.756.30.045	22.757.30.065	22.758.36.035	22.759.36.045	22.760.36.065
Preis [EUR]	18,-	18,-	18,-	18,-	18,-	18,-

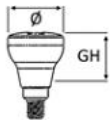

Plattform	4,2	4,2	4,2	4,8	4,8	4,8
GH [mm]	3,5	4,5	6,5	3,5	4,5	6,5
Ø [mm]	5,0	5,0	5,0	6,5	6,5	6,5
REF	22.761.42.035	22.762.42.045	22.763.42.065	22.764.48.035	22.765.48.045	22.767.48.065
Preis [EUR]	18,-	18,-	18,-	18,-	18,-	18,-

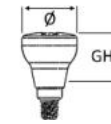

[Per Klick zum Webshop](#)

Plattform	5,4	5,4	5,4
GH [mm]	3,5	4,5	6,5
Ø [mm]	6,5	6,5	6,5
REF	22.768.54.035	22.769.54.045	22.770.54.065
Preis [EUR]	18,-	18,-	18,-

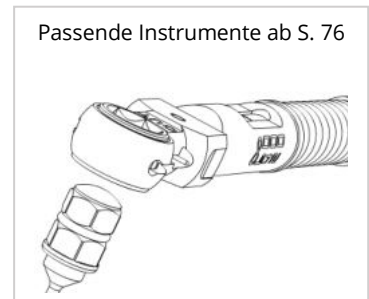
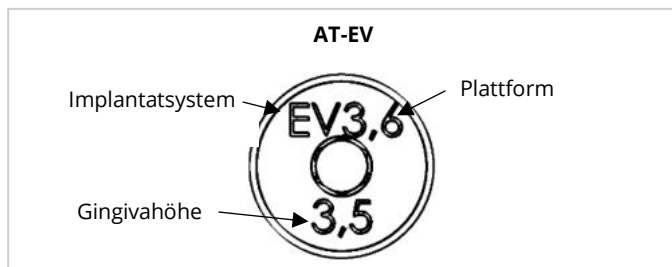

FX Serie - kompatibel zu Dentsply® - Xive® S

FX Serie – kompatibel zu **Dentsply®** – **Xive® S**

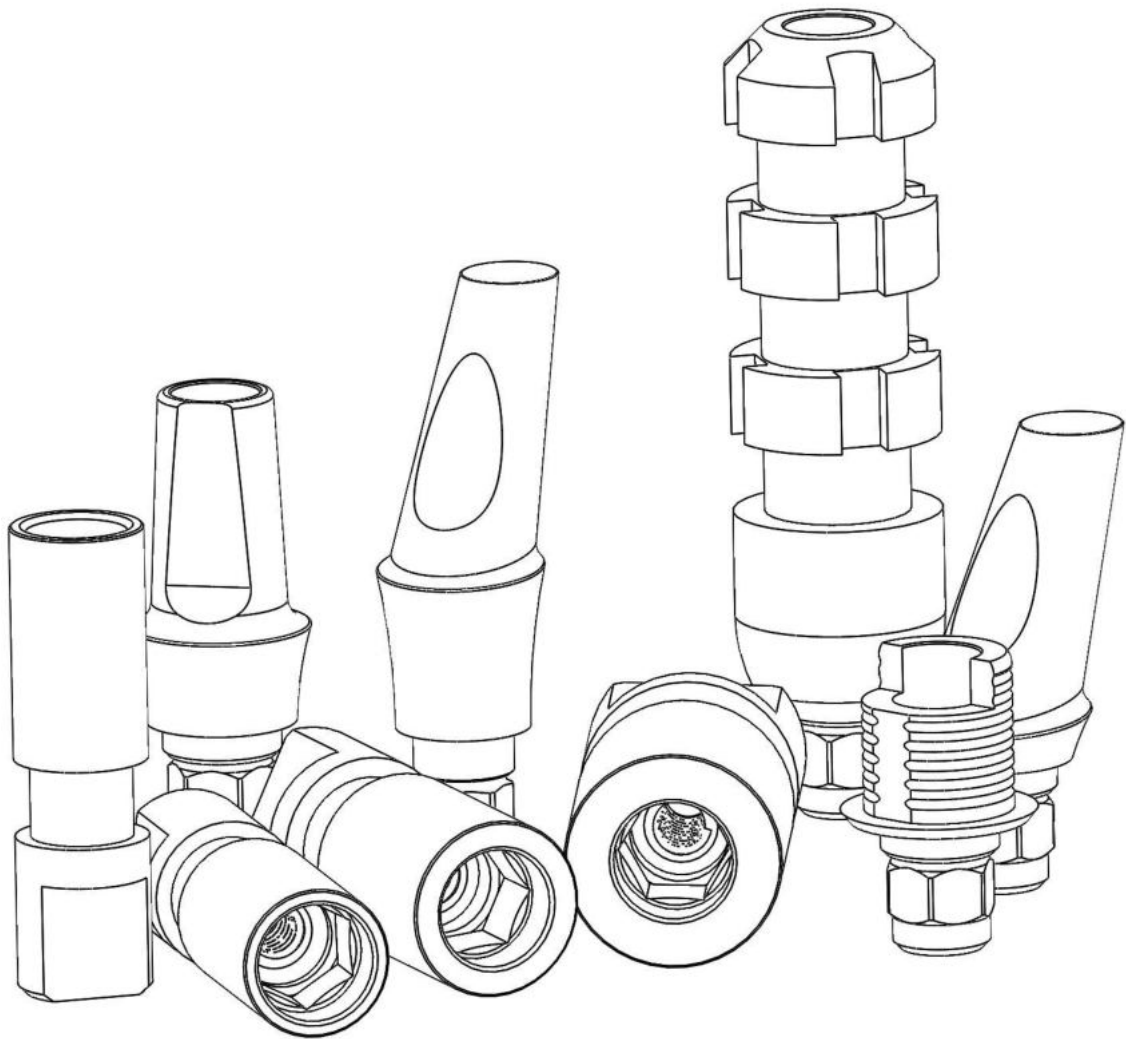

FX Serie - kompatibel zu Dentsply® - Xive® S

Abutmentschrauben

Titan Grade 5, unsteril, Anschluss: Hex 1,22



Passende Instrumente ab S. 76

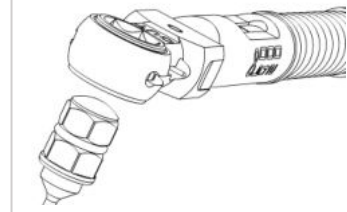

Plattform	3,4 / 3,8 / 4,5 / 5,5	Multi-Unit
Größe	M1,6	M1,4
REF	21.577.16.083	21.731.21.035
Preis [EUR]	10,-	10,-

Laborschrauben

Titan Grade 5, unsteril, Anschluss: Hex 1,22, farbcodiert gelb



[Per Klick zum Webshop](#)

Plattform	3,4 / 3,8 / 4,5 / 5,5	Multi-Unit
Größe	M1,6	M1,4
REF	24.024.00.083	24.109.21.035
Preis [EUR]	6,-	6,-
ab 5 Stk.	4,-	4,-
ab 10 Stk.	3,50	3,50

Laboranaloge

Titan Grade 5, unsteril, farbcodiert, für 3D Druck geeignet

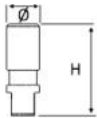

Plattform	3,4	3,8	4,5 / 5,5
H [mm]	12	12	12
Ø [mm]	3,4	3,8	4,5
Farbcodierung	keine	gelb	blau
REF	24.020.34.010	24.021.38.010	24.022.45.010
Preis [EUR]	12,-	12,-	12,-
ab 10 Stk.	9,-	9,-	9,-
ab 30 Stk.	8,-	8,-	8,-

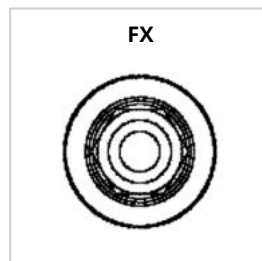

Suitable instruments page 76

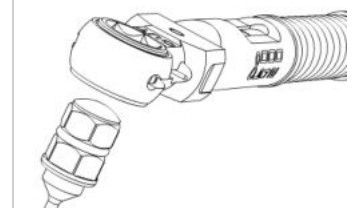

Gerade Abutments

Titan Grade 5, unsteril, inkl. Schraube / Drehmoment: 25 Ncm

 **KLICK ZUM WEBSHOP**

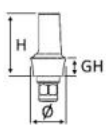

		3,4	3,8	4,5	5,5
Plattform					
<i>H [mm]</i>		6	6	6	6
<i>Ø [mm]</i>		4,2	4,6	5,3	6,3
REF	GH 1 mm	21.598.34.000	21.601.38.000	21.604.45.000	21.607.55.000
REF	GH 2,5 mm	21.599.34.000	21.602.38.000	21.605.45.000	21.608.55.000
<i>Preis [EUR]</i>		60,-	60,-	60,-	60,-

Gewinkelte Abutments / 15 Grad

Titan Grade 5, unsteril, inkl. Schraube / Drehmoment: 25 Ncm

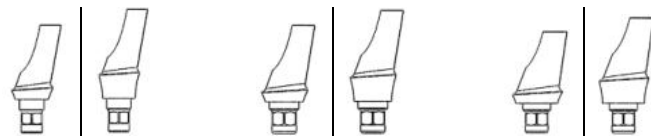

		3,4	3,8	4,5
Plattform				
<i>H [mm]</i>		7	7	7
<i>Ø [mm]</i>		4,2	4,6	5,3
REF	Typ 1 15° GH 1 mm	21.622.34.000	21.625.38.000	21.628.45.000
REF	Typ 1 15° GH 2,5 mm	21.623.34.000	21.626.38.000	21.629.45.000
<i>Preis [EUR]</i>		75,-	75,-	75,-

Gewinkelte Abutments / 25 Grad

Titan Grade 5, unsteril, inkl. Schraube / Drehmoment: 25 Ncm

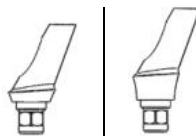
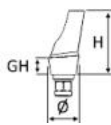

 **KLICK ZUM WEBSHOP**

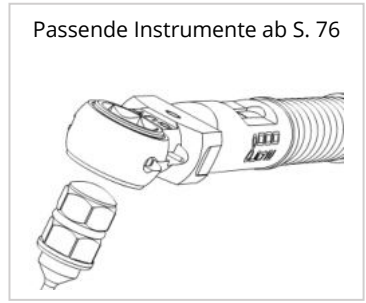

		3,8
Plattform		
<i>H [mm]</i>		7
<i>Ø [mm]</i>		4,6
REF	Typ 1 25° GH 1 mm	21.903.38.000
REF	Typ 1 25° GH 2,5 mm	21.904.38.000
<i>Preis [EUR]</i>		75,-



Titanbasen kurz, CAD/CAM

Titan Grade 5, unsteril, inkl. Schraube / Drehmoment: 25 Ncm / kompatibel mit: Exocad® & 3shape®

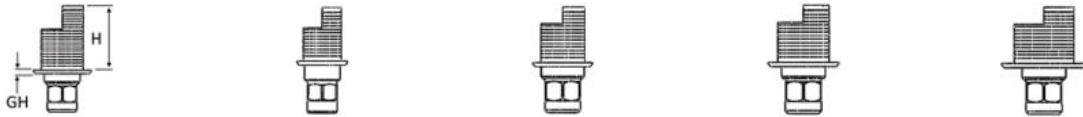

Plattform		3,4	3,8	4,5	5,5
	GH [mm]	0,3	0,3	0,3	0,3
	H [mm]	4	4	4	4
REF	Typ 1	21.686.34.000	21.687.38.000	21.688.45.000	21.689.55.000
	Preis [EUR]	45,-	45,-	45,-	45

Titanbasen lang, CAD/CAM

Titan Grade 5, unsteril, inkl. Schraube / Drehmoment: 25 Ncm / kompatibel mit: Exocad® & 3shape®



Plattform		3,4	3,8	4,5	5,5
	H [mm]	0,3	0,3	0,3	0,3
	H [mm]	5,5	5,5	5,5	5,5
REF		21.735.34.000	21.736.38.000	21.737.45.000	21.738.55.000
	Preis [EUR]	45,-	45,-	45,-	45,-

KLICK ZUM
WEBSHOP

Titanbasen nicht indexiert, CAD/CAM

Titan Grade 5, unsteril, inkl. Schraube / Drehmoment: 25 Ncm / ohne Rotationsschutz / kompatibel mit: Exocad® & 3shape®



Plattform		3,4	3,8	4,5	5,5
	GH [mm]	0,3	0,3	0,3	0,3
	H [mm]	4	4	4	4
REF		21.702.34.000	21.703.38.000	21.704.45.000	21.705.55.000
	Preis [EUR]	40,-	40,-	40,-	40,-

Scanbodys

Titan Grade 4, unsteril, inkl. Schraube / Drehmoment: Handfest



Plattform		3,4	3,8	4,5	5,5
REF		21.710.34.000	21.711.38.000	21.712.45.000	21.713.55.000
	Preis [EUR]	30,-	30,-	30,-	30,-

KLICK ZUM
WEBSHOP

Pre-Mill Abutments

Titan Grade 5, unsteril, inkl. Schraube / Drehmoment: 25 Ncm, kompatibel zum Medentika®-Halter



Plattform	3,4	3,8 / 4,5 / 5,5	3,8 / 4,5 / 5,5
Ø [mm]	11,5	11,5	15,8
REF	25.095.11.000	25.101.11.000	25.103.15.000
Preis [EUR]	37,-	37,-	37,-

Multi-Unit Abutments D3,4

Titan Grade 5, unsteril / Drehmoment: 25 Ncm



Plattform	3,4	3,4	3,4
GH [mm]	1	2	3
REF	21.714.34.010	21.715.34.020	21.716.34.030
Preis [EUR]	49,-	49,-	49,-

Passende Instrumente ab S. 76

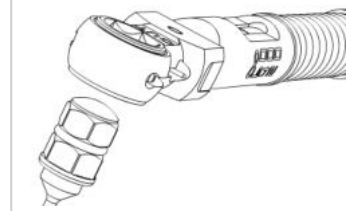

Multi-Unit Abutments D3,8

Titan Grade 5, unsteril / Drehmoment: 25 Ncm



Per Klick zum Webshop

Plattform	3,8	3,8	3,8
GH [mm]	1	2	3
REF	21.718.38.010	21.719.38.020	21.720.38.030
Preis [EUR]	49,-	49,-	49,-

Multi-Unit Abutments D4,5

Titan Grade 5, unsteril / Drehmoment: 25 Ncm



Plattform	4,5	4,5	4,5
GH [mm]	1	2	3
REF	21.722.45.010	21.723.45.020	21.724.45.030
Preis [EUR]	49,-	49,-	49,-

Multi-Unit Zubehör

Titan Grade 5, unsteril, Anschluss: Hex 1,22

KLICK ZUM WEBSHOP



Titanbasis Multi-Unit, CAD/CAM **Titankappe Multi-Unit** **Gingivaformer Multi-Unit** **Scanbody Multi-Unit** **Abformpfosten Multi-Unit (offene Abformung)** **Laboranalog Multi-Unit**

<i>Material inkl. Schraube</i>	Titan Grade 5	Titan Grade 5	Titan Grade 5	Titan Grade 4	Titan Grade 5	Titan Grade 5
<i>Drehmoment</i>	ja	ja	nein	ja	ja	nein
<i>REF</i>	15 Ncm	15 Ncm	Handfest	Handfest	Handfest	-
<i>Preis [EUR]</i>	21.733.00.000	21.732.00.000	21.730.45.037	21.734.00.000	23.076.00.000	24.048.45.100
	39,-	39,-	18,-	30,-	26,-	12,-

Abformpfosten kurz (offene Abformung)

Titan Grade 5, unsteril, inkl. Schraube, farbcodiert / Drehmoment: Handfest

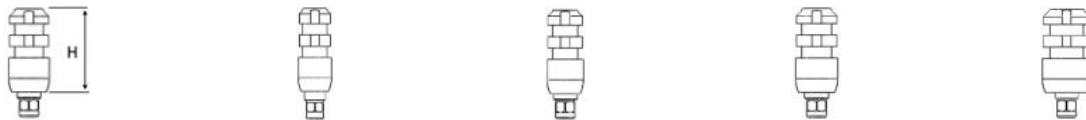

Plattform	3,4	3,8	4,5	5,5
<i>H [mm]</i>	11	11	11	11
<i>Farbcodierung</i>	keine	gelb	blau	rot
<i>REF</i>	23.082.34.000	23.083.38.000	23.084.45.000	23.085.55.000
<i>Preis [EUR]</i>	26,-	26,-	26,-	26,-

Abformpfosten lang (offene Abformung)

Titan Grade 5, unsteril, inkl. Schraube, farbcodiert / Drehmoment: Handfest

KLICK ZUM WEBSHOP

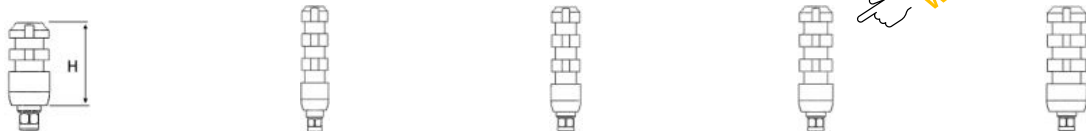

Plattform	3,4	3,8	4,5	5,5
<i>H [mm]</i>	17	17	17	17
<i>Farbcodierung</i>	keine	gelb	blau	rot
<i>REF</i>	23.091.34.000	23.092.38.000	23.093.45.000	23.094.55.000
<i>Preis [EUR]</i>	26,-	26,-	26,-	26,-

Abformpfosten (geschlossene Abformung)

Titan Grade 5, unsteril, inkl. Schraube and Kappe, farbcodiert / Drehmoment: Handfest



Plattform	3,4	3,8	4,5	5,5	Reponierkappen 5 Stk.
<i>H [mm]</i>	10,5	10,5	10,5	10,5	
<i>Farbcodierung</i>	keine	gelb	blau	rot	transparent
<i>REF</i>	23.259.34.011	23.260.38.011	23.261.45.011	23.262.55.011	23.999.48.000
<i>Preis [EUR]</i>	29,-	29,-	29,-	29,-	12,-

Gingivaformer

Titan Grade 5, unsteril, inkl. Schraube, lasermarkiert / Drehmoment: Handfest

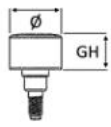

Per Klick zum Webshop

Plattform	3,4	3,4	3,4
GH [mm]	3	4	5
Ø [mm]	4,5	4,5	4,5
REF	22.585.34.030	22.586.34.040	22.587.34.050
Preis [EUR]	18,-	18,-	18,-

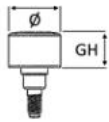

Plattform	3,8	3,8	3,8
GH [mm]	3	4	5
Ø [mm]	4,5	4,5	4,5
REF	22.589.38.030	22.590.38.040	22.591.38.050
Preis [EUR]	18,-	18,-	18,-

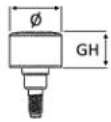

Plattform	4,5	4,5	4,5
GH [mm]	3	4	5
Ø [mm]	4,9	4,9	4,9
REF	22.593.45.030	22.594.45.040	22.595.45.050
Preis [EUR]	18,-	18,-	18,-

KLICK ZUM WEBSHOP

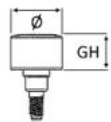

Plattform	5,5	5,5	5,5
GH [mm]	3	4	5
Ø [mm]	5,9	5,9	5,9
REF	22.597.55.030	22.598.55.040	22.599.55.050
Preis [EUR]	18,-	18,-	18,-

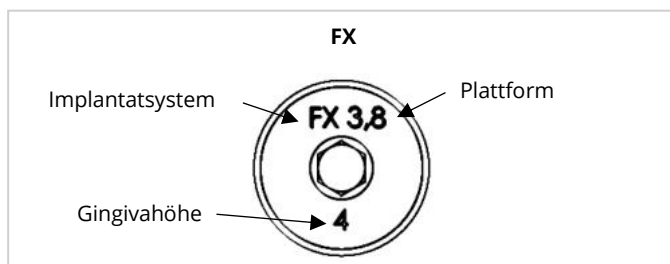

DS-AY Serie - kompatibel zu **Dentsply® - Ankylos® C/X**

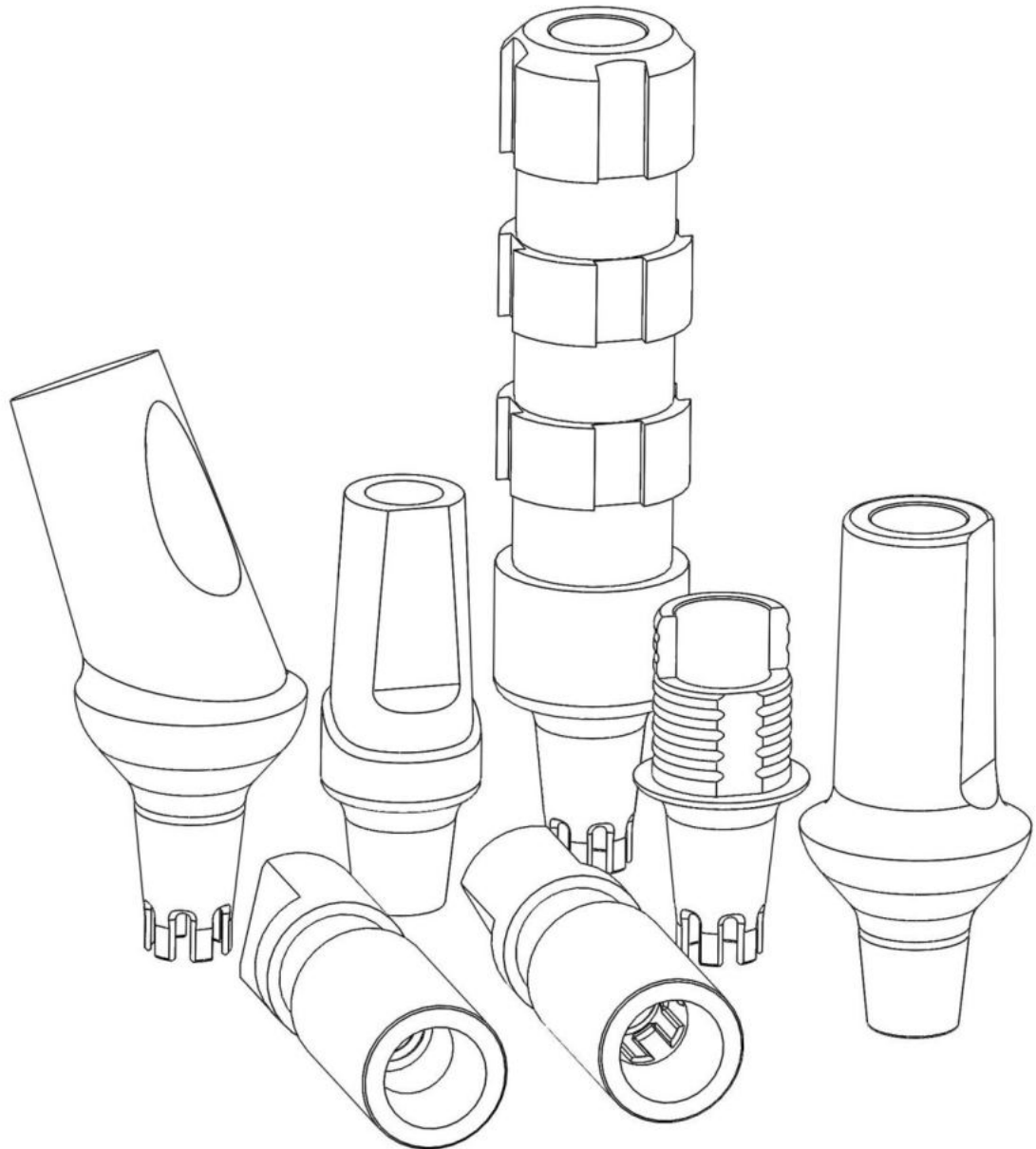

(X): mit Rotationssicherung / Index

(C): ohne Rotationssicherung / Index

Abutmentschrauben

Titan Grade 5, unsteril, Anschluss: Hex 1,01



Plattform	A / B / C / D	Multi-Unit
Größe	M1,8	M1,4
REF	22.679.18.095	22.748.21.035
Preis [EUR]	10,-	10,-

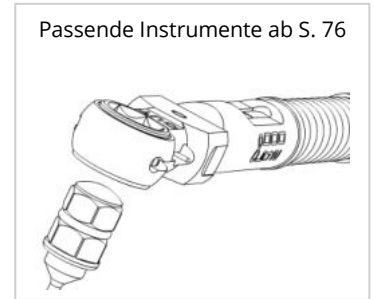

Laborschrauben

Titan Grade 5, unsteril, Anschluss: Hex 1,01, farbcodiert gelb



Plattform	A / B / C / D	Multi-Unit
Größe	M1,8	M1,4
REF	24.093.18.095	24.110.21.035
Preis [EUR]	6,-	6,-
ab 5 Stk.	4,-	4,-
ab 10 Stk.	3,50	3,50

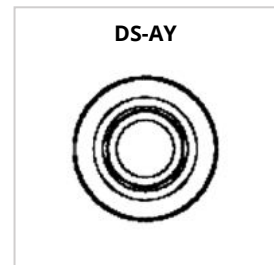

Laboranaloge

Titan Grade 5, unsteril, farbcodiert, für 3D Druck geeignet



 [Per Klick zum Webshop](#)

Plattform	A / B / C / D (C)	A / B / C / D (X)
H [mm]	12	12
Ø [mm]	3,5	3,5
Farbcodierung	keine	rot
REF	24.079.00.100	24.081.00.120
Preis [EUR]	12,-	12,-
ab 10 Stk.	9,-	9,-
ab 30 Stk.	8,-	8,-

Gerade Abutments

Titan Grade 5, unsteril, inkl. Schraube / Drehmoment: 25 Ncm



Plattform	A / B / C / D (X)	A / B / C / D (X)	A / B / C / D (C)	A / B / C / D (C)
GH [mm]	1,5	3,0	1,5	3,0
H [mm]	9	10,5	9	10,5
Ø [mm]	5,4	5,4	5,4	5,4
REF	22.694.54.001	22.695.54.001	22.692.54.000	22.693.54.000
Preis [EUR]	60,-	60,-	60,-	60,-

Gewinkelte Abutments (X)

Titan Grade 5, unsteril, inkl. Schraube / Drehmoment: 25 Ncm

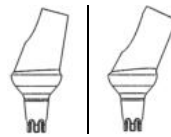
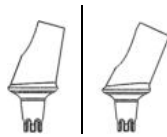
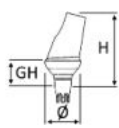

 [Per Klick zum Webshop](#)

Plattform	A / B / C / D	A / B / C / D
GH [mm]	1,5	3
H [mm]	7	7
Ø [mm]	5,4	5,4
REF 15°	22.708.54.001	22.710.54.001
REF 25°	22.709.54.001	22.711.54.001
Preis [EUR]	75,-	75,-

Nicht indizierte Abutments (C)

Titan Grade 5, unsteril, inkl. Schraube / Drehmoment: 25 Ncm

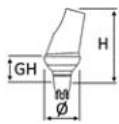

Plattform	A / B / C / D	A / B / C / D
GH [mm]	1,5	3
H [mm]	7	7
Ø [mm]	5,4	5,4
REF 15°	22.704.54.000	22.706.54.000
Preis [EUR]	75,-	75,-

Titanbasen, CAD/CAM

Titan Grade 5, unsteril, inkl. Schraube / Drehmoment: 25 Ncm / kompatibel mit: Exocad® & 3shape®

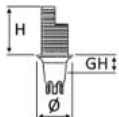

 [KLICK ZUM WEBSHOP](#)

Plattform	A / B / C / D (X)	A / B / C / D (X)	A / B / C / D (C)
GH [mm]	1,0	1,0	1,0
H [mm]	4	5,5	4
Ø [mm]	4,1	4,1	4,1
REF	22.739.41.001	22.740.41.001	22.741.41.000
Preis [EUR]	45,-	45,-	40,-

Passende Instrumente ab S. 76

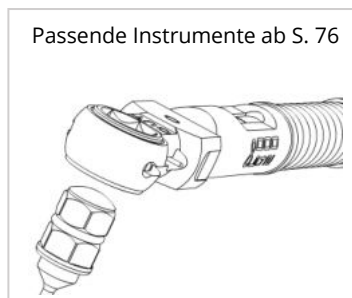

Scanbodys

Titan Grade 4, unsteril, inkl. Schraube / Drehmoment: Handfest



Passende Instrumente ab S. 76

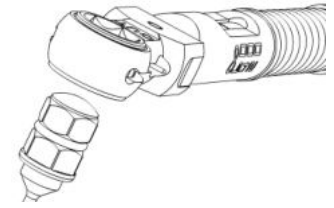

Plattform	A / B / C / D
REF	22.743.41.001
Preis [EUR]	30,-

Pre-Mill Abutments

Titan Grade 5, unsteril, inkl. Schraube / Drehmoment: 25 Ncm, kompatibel zum Medentika®-Halter

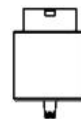

Plattform	11,5	15,8
Ø [mm]	11,5	15,8
REF	25.264.11.001	25.266.15.001
Preis [EUR]	37,-	37,-

Multi-Unit Abutments

Titan Grade 5, unsteril / Drehmoment: 25 Ncm

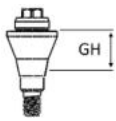

[Per Klick zum Webshop](#)

Plattform	A / B / C / D	A / B / C / D	A / B / C / D
GH [mm]	1,5	3,0	4,5
REF	22.744.37.015	22.745.37.030	22.746.37.045
Preis [EUR]	49,-	49,-	49,-

Multi-Unit Zubehör

Titan Grade 5, unsteril, Anschluss: Hex 1,01



**Titanbasis
Multi-Unit,
CAD/CAM**

**Titankappe
Multi-Unit**

**Gingivaformer
Multi-Unit**

**Scanbody
Multi-Unit**

**Abformpfosten
Multi-Unit
(offene
Abformung)**

**Laboranalog
Multi-Unit**

	Titan Grade 5	Titan Grade 5	Titan Grade 5	Titan Grade 4	Titan Grade 5	Titan Grade 5
Material	Titan Grade 5	Titan Grade 5	Titan Grade 5	Titan Grade 4	Titan Grade 5	Titan Grade 5
inkl. Schraube	ja	ja	nein	ja	ja	nein
Drehmoment	15 Ncm	15 Ncm	Handfest	Handfest	Handfest	-
REF	22.750.42.000	22.676.30.000	22.747.45.037	22.751.00.000	23.180.00.000	24.048.45.100
Preis [EUR]	39,-	39,-	18,-	30,-	26,-	12,-

Abformpfosten (offene Abformung)

Titan Grade 5, unsteril, inkl. Schraube / Drehmoment: Handfest

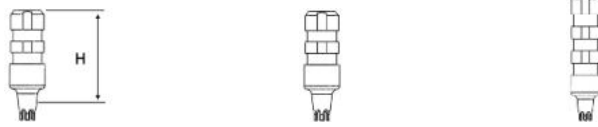

Plattform	A / B / C / D	A / B / C / D
H [mm]	11	17
Farbcodierung	keine	keine
REF	23.183.45.001	23.186.45.001
Preis [EUR]	26,-	26,-

Passende Instrumente ab S. 76

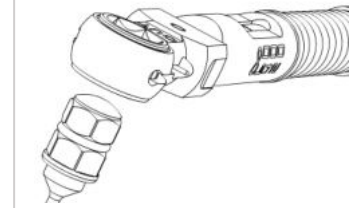

Abformpfosten (geschlossene Abformung)

Titan Grade 5, unsteril, inkl. Schraube, farbcodiert / Drehmoment: Handfest



Plattform	A / B / C / D	Reponierkappen 5 Stk.
H [mm]	10,5	
Farbcodierung	keine	transparent
REF	23.283.00.011	23.999.48.000
Preis [EUR]	29,-	12,-

Gingivaformer

Titan Grade 5, unsteril, lasermarkiert / Drehmoment: Handfest



 [Per Klick zum Webshop](#)

Plattform	A / B / C / D	A / B / C / D	A / B / C / D
GH [mm]	1,5	3	4,5
Ø [mm]	4,5	4,5	4,5
REF	22.752.00.015	22.753.00.030	22.754.00.045
Preis [EUR]	18,-	18,-	18,-

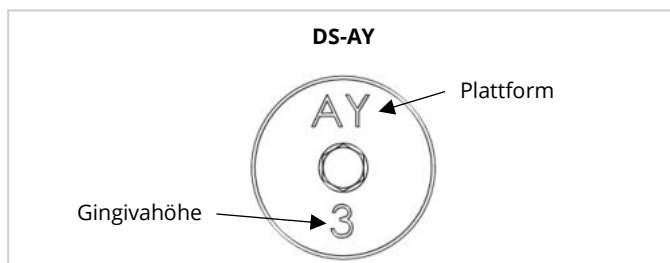

ZMB Serie - kompatibel zu **Zimmer Dental® - TSRV / MIS® - Seven® / Biohorizons® - Internal Hex**

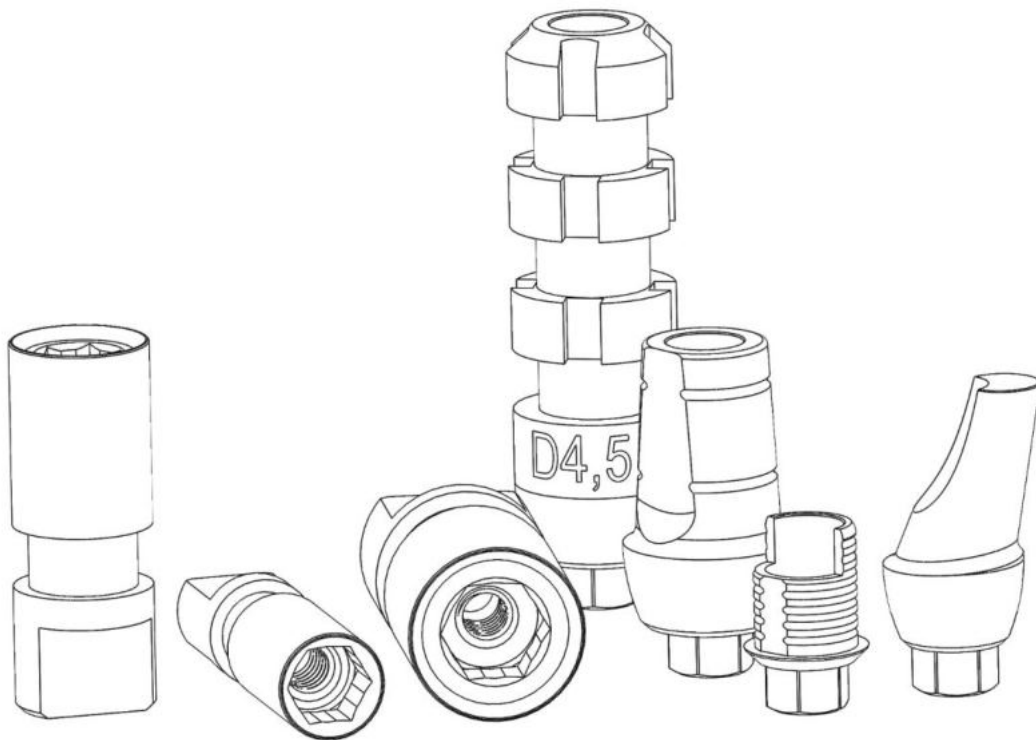

Zimmer Dental®

Implantatdurchmesser	3,7 & 4,1	4,7	6,0
Plattform	3,5	4,5	5,7
Farbe der prot. Plattform	grün	lila	gelb

MIS®

Implantatdurchmesser	3,75 SP & 4,20 SP	5 WP & 6 WP
Plattform	3,5	4,5
Farbe der prot. Plattform	lila	grün

SP = Standard Plattform / WP = Weite Plattform

Biohorizons®

Implantatdurchmesser	3,0* & 3,8	4,6	5,8
Plattform	3,5	4,5	5,7
Farbe der prot. Plattform	gelb	grün	blau

*) Nur für Tapered Tissue Level Implantate

Abutmentschrauben

Titan Grade 5, unsteril, Anschluss: Hex 1,26



Plattform	3,5 / 4,5 / 5,7	Multi-Unit
<i>Größe</i>	M1,8	M1,4
<i>REF</i>	21.000.00.072	21.094.21.035
<i>Preis [EUR]</i>	10,-	10,-

Laborschrauben

Titan Grade 5, unsteril, Anschluss: Hex 1,26, farbcodiert gelb



Plattform	3,5 / 4,5 / 5,7	Multi-Unit
<i>Größe</i>	M1,8	M1,4
<i>REF</i>	24.013.00.072	24.107.21.035
<i>Preis [EUR]</i>	6,-	6,-
<i>ab 5 Stk.</i>	4,-	4,-
<i>ab 10 Stk.</i>	3,50	3,50

Passende Instrumente ab S. 76

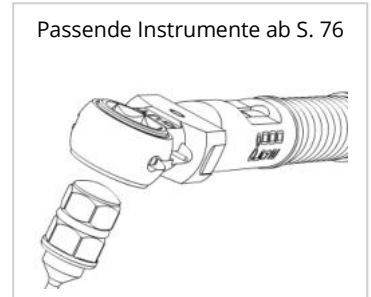

Laboranaloge

Titan Grade 5, unsteril, farbcodiert, für 3D Druck geeignet

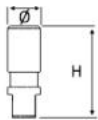

**KLICK ZUM
WEBSHOP**

Plattform	3,5	4,5	5,7
<i>H [mm]</i>	12	12	12
<i>Ø [mm]</i>	3,5	4,5	5,7
<i>Farbcodierung</i>	grün	lila	gelb
<i>REF</i>	24.010.35.010	24.011.45.010	24.012.57.010
<i>Preis [EUR]</i>	12,-	12,-	12,-
<i>ab 10 Stk.</i>	9,-	9,-	9,-
<i>ab 30 Stk.</i>	8,-	8,-	8,-

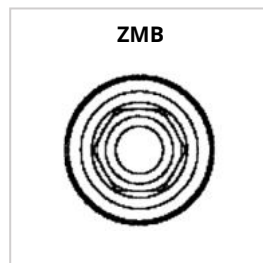

Gerade Abutments

Titan Grade 5, unsteril, inkl. Schraube / Drehmoment: 30 Ncm



Plattform	3,5	3,5	4,5	4,5	5,7	5,7
GH [mm]	1	2,5	1	2,5	1	2,5
H [mm]	7,5	9,1	7,5	9,1	7,5	9,1
Ø [mm]	4,3	4,5	5,2	5,5	6	6,5
REF	21.017.35.000	21.020.35.000	21.018.45.000	21.021.45.000	21.019.57.000	21.022.57.000
Preis [EUR]	60,-	60,-	60,-	60,-	60,-	60,-

Gewinkelte Abutments / 16 Grad

Titan Grade 5, unsteril, inkl. Schraube / Drehmoment: 30 Ncm



Plattform	3,5	3,5	4,5	4,5
GH [mm]	1	2,5	1	2,5
H [mm]	6,8	8,3	6,8	8,3
Ø [mm]	4,3	4,5	5,2	5,5
REF Typ 1 (16°)	21.029.35.000	21.041.35.000	21.030.45.000	21.042.45.000
Preis [EUR]	75,-	75,-	75,-	75,-

Gewinkelte Abutments / 25 Grad

Titan Grade 5, unsteril, inkl. Schraube / Drehmoment: 30 Ncm



Plattform	3,5	3,5	4,5	4,5
GH [mm]	1	2,5	1	2,5
H [mm]	6,8	8,3	6,8	8,3
Ø [mm]	4,3	4,5	5,2	5,5
REF Typ 1 (25°)	21.194.35.000	21.206.35.000	21.195.45.000	21.207.45.000
Preis [EUR]	75,-	75,-	75,-	75,-

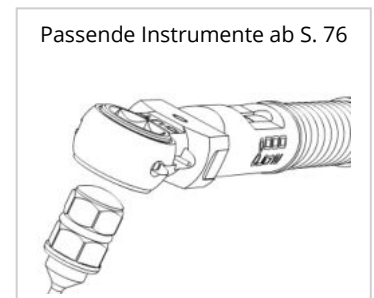

Titanbasen kurz, CAD/CAM

Titan Grade 5, unsteril, inkl. Schraube / Drehmoment: 30 Ncm / kompatibel mit: Exocad® & 3shape®

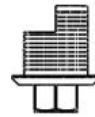
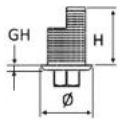

Plattform	3,5	4,5	5,7
GH [mm]	0,4	0,4	0,4
H [mm]	4	4	4
Ø [mm]	4	5	6,1
REF Typ 1	21.056.35.000	21.057.45.000	21.058.57.000
Preis [EUR]	45,-	45,-	45,-

Titanbasen lang, CAD/CAM

Titan Grade 5, unsteril, inkl. Schraube / Drehmoment: 30 Ncm / kompatibel mit: Exocad® & 3shape®

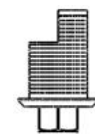
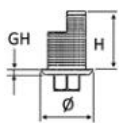

Plattform	3,5	4,5	5,7
GH [mm]	0,4	0,4	0,4
H [mm]	5,5	5,5	5,5
Ø [mm]	4	5	6,1
REF Typ 1	21.062.35.000	21.063.45.000	21.064.57.000
Preis [EUR]	45,-	45,-	45,-

Titanbasen nicht indiziert, CAD/CAM

Titan Grade 5, unsteril, inkl. Schraube / Drehmoment: 30 Ncm / kompatibel mit: Exocad® & 3shape®

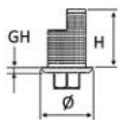

**KLICK ZUM
WEBSHOP**

Plattform	3,5	4,5	5,7
GH [mm]	0,4	0,4	0,4
H [mm]	3,5	3,5	3,5
Ø [mm]	4	5	6,1
REF	21.068.35.000	21.069.45.000	21.070.57.000
Preis [EUR]	40,-	40,-	40,-

Passende Instrumente ab S. 76

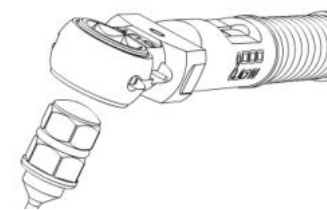

Scanbodys

Titan Grade 4, unsteril, inkl. Schraube / Drehmoment: Handfest



Plattform	3,5	4,5	5,7
REF	21.333.35.127	21.334.45.127	21.335.57.127
Preis [EUR]	30,-	30,-	30,-

Pre-Mill Abutments

Titan Grade 5, unsteril, inkl. Schraube / Drehmoment: 30 Ncm, kompatibel zum Medentika®-Halter

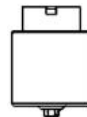

Plattform	3,5	4,5
Ø [mm]	11,5	15,8
REF	25.005.11.000	25.015.15.000
Preis [EUR]	37,-	37,-

Multi-Unit Abutments D3,5

Titan Grade 5, unsteril / Drehmoment: 30 Ncm

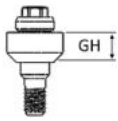

 [Per Klick zum Webshop](#)

Plattform	3,5	3,5	3,5	3,5
GH [mm]	1,5	2,5	3,5	4,5
REF	21.075.35.073	21.076.35.083	21.077.35.093	21.078.35.102
Preis [EUR]	49,-	49,-	49,-	49,-

Multi-Unit Abutments D4,5

Titan Grade 5, unsteril / Drehmoment: 30 Ncm



Plattform	4,5	4,5	4,5
GH [mm]	1,5	2,5	3,5
REF	21.080.45.072	21.081.45.082	21.082.45.092
Preis [EUR]	49,-	49,-	49,-

Passende Instrumente ab S. 76

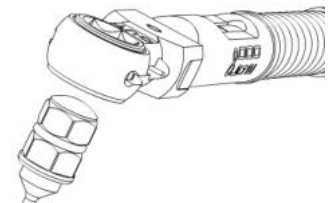

Multi-Unit Zubehör

Titan Grade 5, unsteril, Anschluss: Hex 1,26

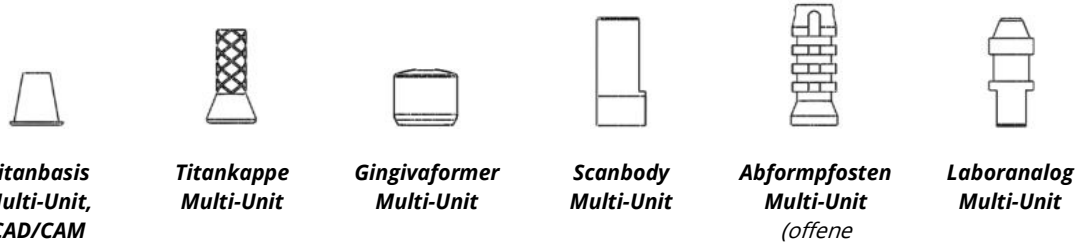

	Titanbasis Multi-Unit, CAD/CAM	Titankappe Multi-Unit	Gingivaformer Multi-Unit	Scanbody Multi-Unit	Abformpfosten Multi-Unit (offene Abformung)	Laboranalog Multi-Unit
Material	Titan Grade 5	Titan Grade 5	Titan Grade 5	Titan Grade 4	Titan Grade 5	Titan Grade 5
inkl. Schraube	ja	ja	nein	ja	ja	nein
Drehmoment	15 Ncm	15 Ncm	Handfest	Handfest	Handfest	-
REF	21.098.42.000	21.096.30.000	21.093.45.037	21.182.00.000	23.019.00.000	24.048.45.100
Preis [EUR]	39,-	39,-	18,-	30,-	26,-	12,-

Abformpfosten kurz (offene Abformung)

Titan Grade 5, unsteril, inkl. Schraube, lasermarkiert / Drehmoment: Handfest



	3,5	4,5	5,7
Plattform	3,5	4,5	5,7
H [mm]	11,5	11,5	11,5
Farbcodierung	keine	keine	keine
REF	23.007.35.000	23.008.45.000	23.009.57.000
Preis [EUR]	26,-	26,-	26,-

Abformpfosten lang (offene Abformung)

Titan Grade 5, unsteril, inkl. Schraube, lasermarkiert / Drehmoment: Handfest



[KLICK ZUM WEBSHOP](#)

	3,5	4,5	5,7
Plattform	3,5	4,5	5,7
H [mm]	17,5	17,5	17,5
Farbcodierung	keine	keine	keine
REF	23.014.35.000	23.015.45.000	23.016.57.000
Preis [EUR]	26,-	26,-	26,-

Abformpfosten (geschlossene Abformung)

Titan Grade 5, unsteril, inkl. Schraube, lasermarkiert / Drehmoment: Handfest

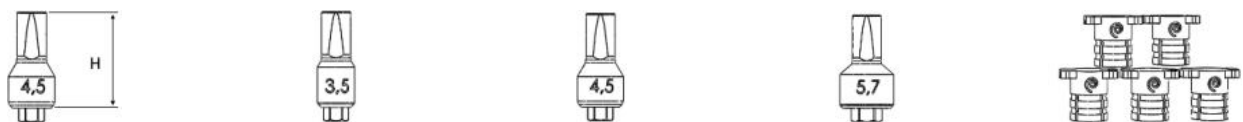

	3,5	4,5	5,7	Reponierkappen 5 Stk.
Plattform	3,5	4,5	5,7	5,7
H [mm]	10,5	10,5	10,5	10,5
Farbcodierung	keine	keine	keine	keine
REF	23.246.35.011	23.247.45.011	23.248.57.011	23.999.48.000
Preis [EUR]	29,-	29,-	29,-	12,-

Gingivaformer

Titan Grade 5, unsteril, inkl. Schraube, lasermarkiert / Drehmoment: Handfest

KLICK ZUM WEBSHOP



Plattform	3,5	3,5	3,5
GH [mm]	3	4	5
Ø [mm]	4,5	4,5	4,5
REF	21.260.35.030	21.261.35.040	21.262.35.050
Preis [EUR]	18,-	18,-	18,-

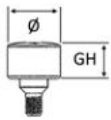

Plattform	4,5	4,5	4,5
GH [mm]	3	4	5
Ø [mm]	4,9	4,9	4,9
REF	21.263.45.030	21.264.45.040	21.265.45.050
Preis [EUR]	18,-	18,-	18,-

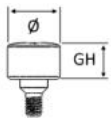

Plattform	5,7	5,7	5,7
GH [mm]	3	4	5
Ø [mm]	5,9	5,9	5,9
REF	21.266.57.030	21.267.57.040	21.268.57.050
Preis [EUR]	18,-	18,-	18,-

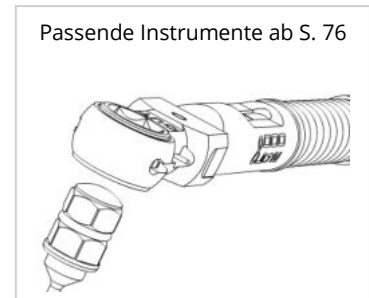
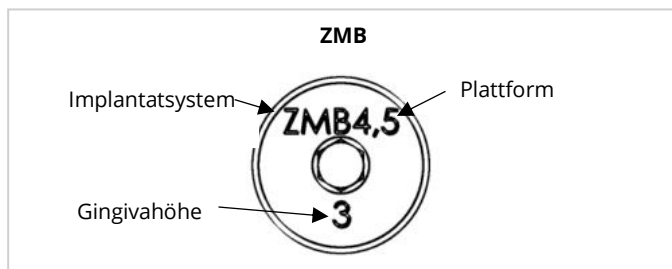

NB-AV Serie - kompatibel zu: Nobel Biocare® - NobelActive® / NobelParallel™ /

NobelReplace® Conical Connection

NB-AV Serie - kompatibel zu **Nobel Biocare® - NobelActive® / NobelParallel™ / NobelReplace® Conical Connection**

compatible to
Nobel Biocare®

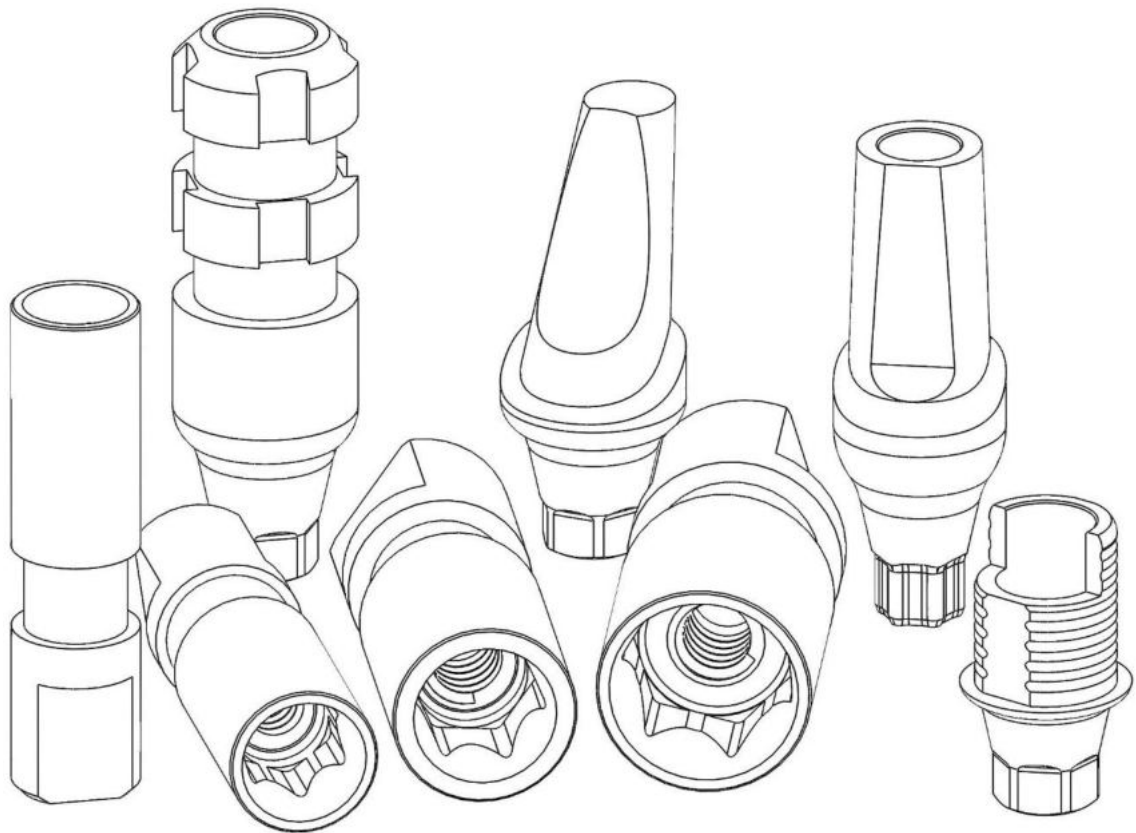

NobelReplace® Conical Connection

Abutmentschrauben

Titan Grade 5, unsteril, Anschluss: UniGrip

KLICK ZUM
WEBSHOP



Plattform	3,0	NP	RP / WP	Multi-Unit
Größe	M1,4	M1,6	M2	M1,4
REF	21.695.14.067	21.696.16.077	21.697.20.080	21.860.21.035
Preis [EUR]	10,-	10,-	10,-	10,-

Laborschrauben

Titan Grade 5, unsteril, Anschluss: UniGrip, farbcodiert gelb



Plattform	3,0	NP	RP / WP	Multi-Unit
Größe	M1,4	M1,6	M2	M1,4
REF	24.100.14.067	24.101.16.077	24.102.20.080	24.111.21.035
Preis [EUR]	6,-	6,-	6,-	6,-
ab 5 Stk.	4,-	4,-	4,-	4,-
ab 10 Stk.	3,50	3,50	3,50	3,50

Laboranaloge

Titan Grade 5, unsteril, farbcodiert, für 3D Druck geeignet

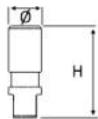

Plattform	3,0	NP	RP	WP
H [mm]	12	12	12	12
Ø [mm]	3,0	3,5	4,3	5,0
Farbcodierung	keine	lila	gelb	blau
REF	24.076.30.100	24.077.35.100	24.078.00.100	24.088.50.120
Preis [EUR]	12,-	12,-	12,-	12,-
ab 10 Stk.	9,-	9,-	9,-	9,-
ab 30 Stk.	8,-	8,-	8,-	8,-

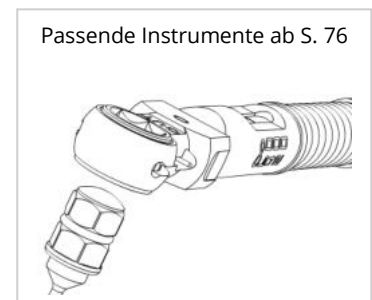
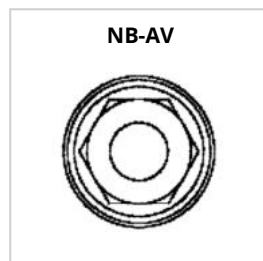

NobelReplace® Conical Connection

Gerade Abutments

Titan Grade 5, unsteril, inkl. Schraube / Drehmoment 3,0: 15 Ncm / NP, RP, WP: 35 Ncm

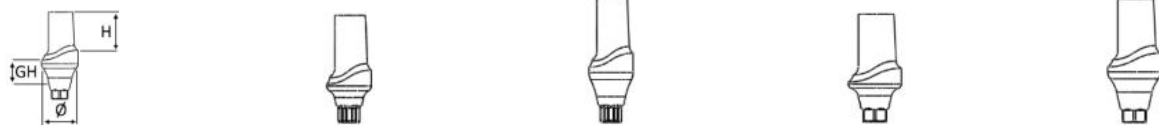

	Plattform	3,0	NP	RP	WP
	H [mm]	5	5	5	5
	Ø [mm]	4	4,5	4,9	5,9
REF	GH 1,5 mm	21.769.30.000	21.771.35.000	21.773.00.000	21.944.55.000
REF	GH 3 mm	21.770.30.000	21.772.35.000	21.774.00.000	21.945.55.000
	Preis [EUR]	60,-	60,-	60,-	60,-

Gewinkelte Abutments

Titan Grade 5, unsteril, inkl. Schraube / Drehmoment: 35 Ncm



	Plattform	NP	NP	RP	RP
	GH [mm]	1,5	3	1,5	3
	H [mm]	5	5	5	5
	Ø [mm]	4,3	4,3	5	5
REF	Typ 1 18°	21.783.35.000	21.784.35.000	21.785.00.000	21.786.00.000
REF	Typ 1 25°	21.872.35.000	21.873.35.000	21.874.00.000	21.875.00.000
	Preis [EUR]	75,-	75,-	75,-	75,-

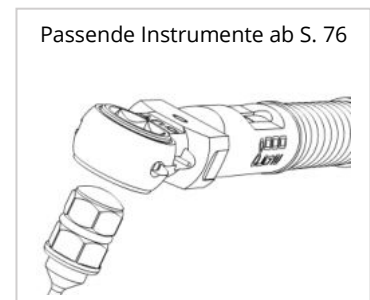
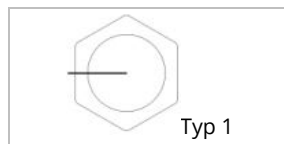

NobelReplace® Conical Connection

Titanbasen kurz, CAD/CAM

Titan Grade 5, unsteril, inkl. Schraube / kompatibel mit: Exocad® & 3shape®

3,0: Drehmoment: 15 Ncm

3,5/4,0 und 4,5/5,0: Drehmoment: 35 Ncm



Plattform		3,0	NP	RP	WP
<i>GH [mm]</i>		0,65	0,65	0,65	0,65
<i>H [mm]</i>		4	4	4	4
<i>REF</i>	Typ 1	21.820.30.000	21.821.35.000	21.822.00.000	21.961.55.000
<i>Preis [EUR]</i>		45,-	45,-	45,-	45,-

Titanbasen lang, CAD/CAM

Titan Grade 5, unsteril, inkl. Schraube / kompatibel mit: Exocad® & 3shape®

3,0: Drehmoment: 15 Ncm

3,5/4,0 und 4,5/5,0: Drehmoment: 35 Ncm



Plattform		3,0	NP	RP	WP
<i>GH [mm]</i>		0,65	0,65	0,65	0,65
<i>H [mm]</i>		5,5	5,5	5,5	5,5
<i>REF</i>	Typ 1	21.826.30.000	21.827.35.000	21.828.00.000	21.963.55.000
<i>Preis [EUR]</i>		45,-	45,-	45,-	45,-

Titanbasen nicht indexiert, CAD/CAM

Titan Grade 5, unsteril, inkl. Schraube / Drehmoment: 35 Ncm / kompatibel mit: Exocad® & 3shape®



Plattform		NP	RP	WP
<i>GH [mm]</i>		0,65	0,65	0,65
<i>H [mm]</i>		4	4	4
<i>REF</i>		21.843.35.000	21.844.00.000	21.969.55.000
<i>Preis [EUR]</i>		40,-	40,-	40,-

NB-AV Serie - kompatibel zu: Nobel Biocare® - NobelActive® / NobelParallel™ /

NobelReplace® Conical Connection

Scanbodys

Titan Grade 4, unsteril, inkl. Schraube / Drehmoment: Handfest



Plattform	3,0	NP	RP	WP
REF	21.848.30.000	21.849.35.000	21.850.00.000	21.971.55.000
Preis [EUR]	30,-	30,-	30,-	30,-

Pre-Mill Abutments

Titan Grade 5, unsteril, inkl. Schraube / Drehmoment 3,0: 15 Ncm / NP, RP, WP: 35 Ncm, kompatibel zum Medentika®-Halter



Plattform	3,0	NP	RP	WP
Ø [mm]	11,5	11,5	15,8	15,8
REF	25.107.11.000	25.113.11.000	25.123.15.000	25.131.15.000
Preis [EUR]	37,-	37,-	37,-	37,-

Multi-Unit Abutments NP

Titan Grade 5, unsteril / Drehmoment: 35 Ncm



Plattform	NP	NP	NP
GH [mm]	1,5	2,5	3,5
REF	21.851.35.015	21.852.35.025	21.853.35.035
Preis [EUR]	49,-	49,-	49,-

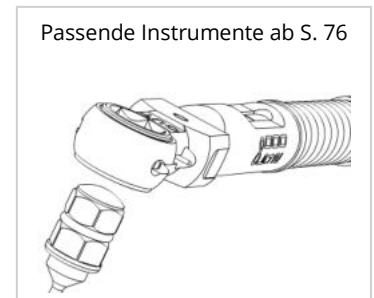

Multi-Unit Abutments RP

Titan Grade 5, unsteril / Drehmoment: 35 Ncm



 [Per Klick zum Webshop](#)

Plattform	RP	RP	RP	RP
GH [mm]	1,5	2,5	3,5	4,5
REF	21.855.00.015	21.856.00.025	21.857.00.035	21.858.00.045
Preis [EUR]	49,-	49,-	49,-	49,-

NobelReplace® Conical Connection

Multi-Unit Zubehör

Titan Grade 5, unsteril, Anschluss: UniGrip



Titanbasis Multi-Unit, CAD/CAM **Titankappe Multi-Unit** **Gingivaformer Multi-Unit** **Scanbody Multi-Unit** **Abformpfosten Multi-Unit (offene Abformung)** **Laboranalog Multi-Unit**

<i>Material</i>	Titan Grade 5	Titan Grade 5	Titan Grade 5	Titan Grade 4	Titan Grade 5	Titan Grade 5
<i>inkl. Schraube</i>	ja	ja	nein	ja	ja	nein
<i>Drehmoment</i>	15 Ncm	15 Ncm	Handfest	Handfest	Handfest	-
<i>REF</i>	21.862.00.000	21.861.00.000	21.859.45.037	21.863.00.000	23.096.00.000	24.048.45.100
<i>Preis [EUR]</i>	39,-	39,-	18,-	30,-	26,-	12,-

Abformpfosten kurz (offene Abformung)

Titan Grade 5, unsteril, inkl. Schraube, farbcodiert / Drehmoment: Handfest

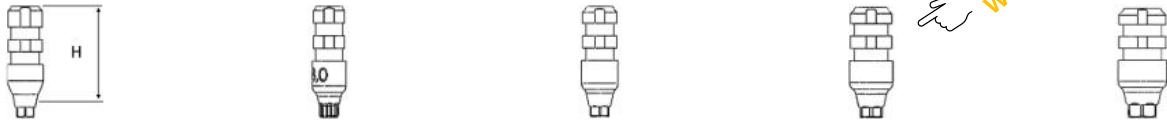

Plattform	3,0	NP	RP	WP
<i>H [mm]</i>	11	11	11	11
<i>Farbcodierung</i>	keine	lila	gelb	blau
<i>REF</i>	23.103.30.000	23.104.35.000	23.105.00.000	23.138.55.000
<i>Preis [EUR]</i>	26,-	26,-	26,-	26,-

Abformpfosten lang (offene Abformung)

Titan Grade 5, unsteril, inkl. Schraube, farbcodiert / Drehmoment: Handfest

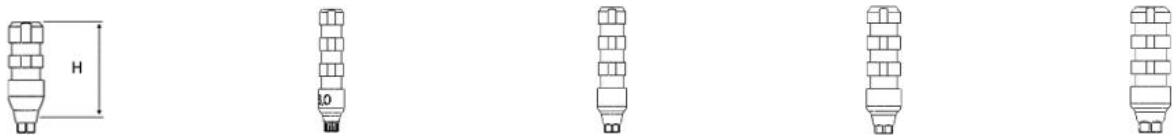

Plattform	3,0	NP	RP	WP
<i>H [mm]</i>	17	17	17	17
<i>Farbcodierung</i>	keine	lila	gelb	blau
<i>REF</i>	23.112.30.000	23.113.35.000	23.114.00.000	23.140.55.000
<i>Preis [EUR]</i>	26,-	26,-	26,-	26,-

Abformpfosten (geschlossene Abformung)

Titan Grade 5, unsteril, inkl. Schraube, farbcodiert / Drehmoment: Handfest



Plattform	NP	RP	WP	Reponierkappen 5 Stk.
<i>H [mm]</i>	10,5	10,5	10,5	
<i>Farbcodierung</i>	lila	gelb	blau	transparent
<i>REF:</i>	23.264.35.011	23.265.43.011	23.266.50.011	23.999.48.000
<i>Price [EUR]:</i>	29,-	29,-	29,-	12,-

NB-AV Serie - kompatibel zu: Nobel Biocare® - NobelActive® / NobelParallel™ /

NobelReplace® Conical Connection

Gingivaformer

Titan Grade 5, unsteril, inkl. Schraube, lasermarkiert / Drehmoment: Handfest

[KLICK ZUM WEBSHOP](#)

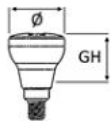

Plattform	3,0	3,0	3,0	NP	NP	NP
GH [mm]	3	4	5	3	4	5
Ø [mm]	3,8	3,8	3,8	4,5	4,5	4,5
REF	21.269.30.030	21.270.30.040	21.271.30.050	21.272.35.030	21.273.35.040	21.274.35.050
Preis [EUR]	18,-	18,-	18,-	18,-	18,-	18,-

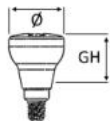

Plattform	RP	RP	RP	WP	WP	WP
GH [mm]	3	4	5	3	4	5
Ø [mm]	4,9	4,9	4,9	5,5	5,5	5,5
REF	21.275.43.030	21.276.43.040	21.277.43.050	21.278.50.030	21.279.50.040	21.280.50.050
Preis [EUR]	18,-	18,-	18,-	18,-	18,-	18,-

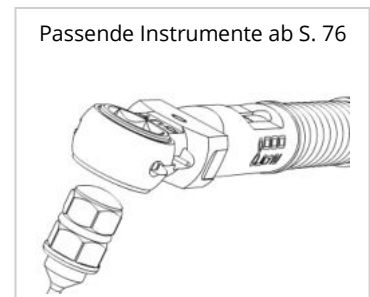
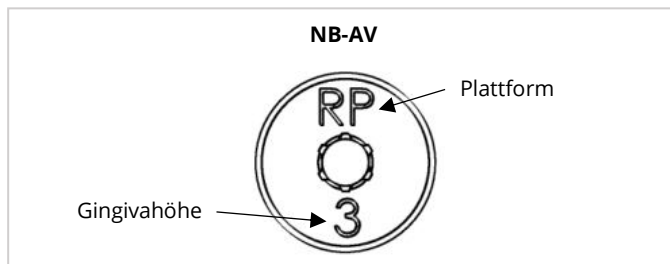

Weitere kompatible Laboranaloge

Kompatibel zu Nobel Biocare® - Nobel Replace Tapered®

Titan Grade 5, unsteril, farbcodiert, für 3D Druck geeignet

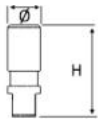

Per Klick zum Webshop

Plattform	NP	RP	WP
H [mm]	12	12	12
Ø [mm]	3,5	4,3	5,0
Farbcodierung	lila	gelb	blau
REF	24.001.35.010	24.002.43.010	24.003.50.010
Preis [EUR]	12,-	12,-	12,-
ab 10 Stk.	9,-	9,-	9,-
ab 30 Stk.	8,-	8,-	8,-

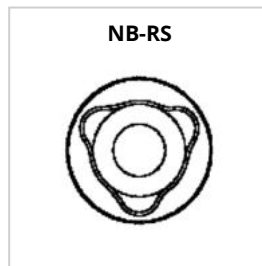

Kompatibel zu Bego® - Semandos® (S / RI / RS / RSX / SC / SCX)

Titan Grade 5, unsteril, farbcodiert, für 3D Druck geeignet

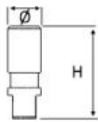

KLICK ZUM
WEBSHOP



Plattform	3,25 / 3,75	4,1	4,5	5,5
H [mm]	12	12	12	12
Ø [mm]	3,67	4,1	4,5	5,5
Farbcodierung	blau	keine	lila	gelb
REF	24.089.37.120	24.090.41.120	24.091.45.120	24.092.55.120
Preis [EUR]	12,-	12,-	12,-	12,-
ab 10 Stk.	9,-	9,-	9,-	9,-
ab 30 Stk.	8,-	8,-	8,-	8,-

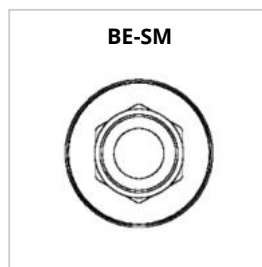

Weitere kompatible Analoge

Kompatibel zu Medentis Medical® - ICX®

Titan Grade 5, unsteril, farbcodiert, für 3D Druck geeignet

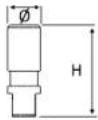

[Per Klick zum Webshop](#)

Plattform	3,75 / 4,1 / 4,8
<i>H [mm]</i>	12
<i>Ø [mm]</i>	3,75
<i>Farbcodierung</i>	rot
<i>REF</i>	24.080.00.120
<i>Preis [EUR]</i>	12,-
<i>ab 10 Stk.</i>	9,-
<i>ab 30 Stk.</i>	8,-

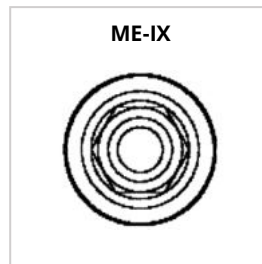

Heli-Loc

Titan Grade 5, unsteril, kompatibel zu Locator® und Locator®-kompatiblen Produkten

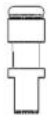

Plattform	4,0
<i>H [mm]</i>	12
<i>Ø [mm]</i>	4,0
<i>Farbcodierung</i>	keine
<i>REF</i>	24.106.40.120
<i>Preis [EUR]</i>	12,-
<i>ab 10 Stk.</i>	9,-
<i>ab 30 Stk.</i>	8,-

Passende Instrumente ab S. 76

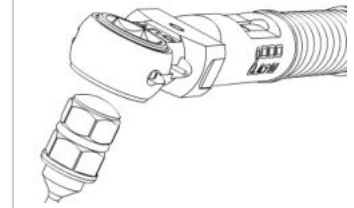

Löseinstrument für DS-AY Serie

Löseinstrument für DS-AY Serie (31.050.71.025)

Zur einfachen Entformung von DS-AY Abutments aus Laboranalogen und Dentsply - Ankylos Implantaten. Zuvor muss die Labor- oder Abutmentschraube entfernt werden. Durch vorsichtiges Drehen wird das DS-AY Abutment axial aus dem Implantat bzw. Analog gelöst.

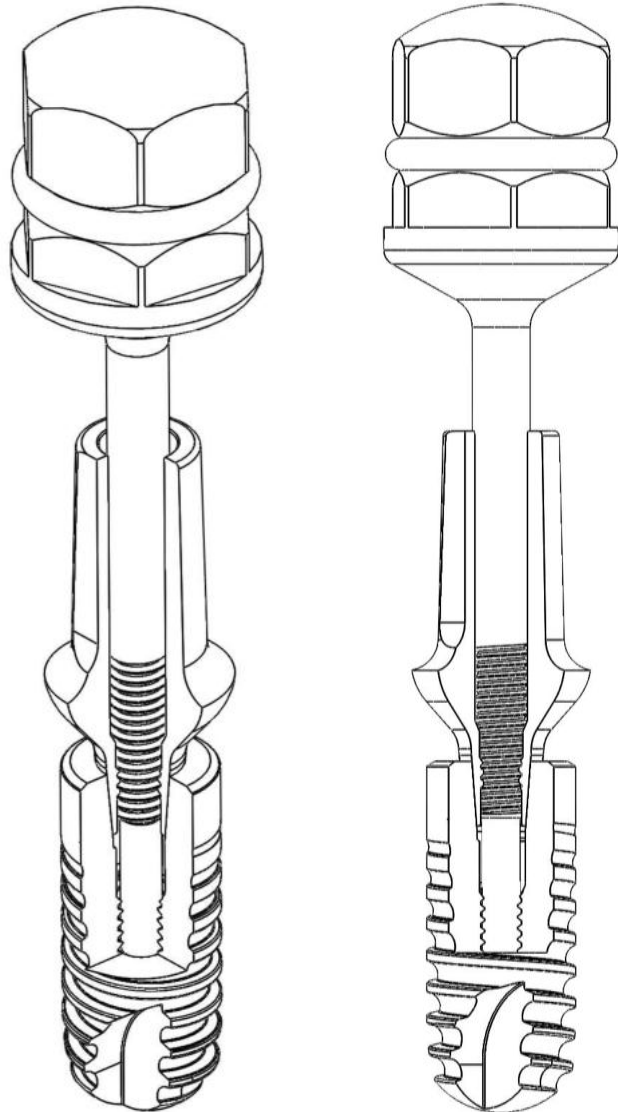

Instrumente

Drehmomentratsche und Universalratsche

[KLICK ZUM WEBSHOP](#)



Länge [mm]	110	54
Anschluss	Hex 6,4	Hex 6,4
Drehmoment	15 – 80 Ncm	-
REF	31.084.15.080	31.037.54.095
Preis [EUR]	150,-	75,-

Adapter und Handrad

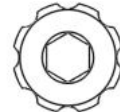
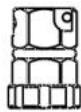

Instrument	Dental DIN EN ISO 1797	Dental DIN EN ISO 1797	Handrad
Anschluss	Hex 6,4	Ø 7 mm (e. g. Straumann®)	Hex 6,4
REF	31.034.64.110	31.035.70.110	31.036.64.060
Preis [EUR]	26,-	26,-	15,-

Torx® T6 - kompatibel zu SM-BL / SM-TL



Anschluss	Hex 6,4	Hex 6,4	Dental DIN EN ISO 1797	Dental DIN EN ISO 1797
Instrument	Torx® T6	Torx® T6	Torx® T6	Torx® T6
Länge [mm]	25	31	25	31
REF	31.022.71.025	31.023.71.031	31.024.23.025	31.025.23.031
Preis [EUR]	30,-	30,-	15,-	15,-

Hex 1,26 - kompatibel zu AT-EV / AT-TX / CL-CO / CL-SR / ZMB

[KLICK ZUM WEBSHOP](#)



Anschluss	Hex 6,4	Hex 6,4	Dental DIN EN ISO 1797	Dental DIN EN ISO 1797
Instrument	Hex 1,26	Hex 1,26	Hex 1,26	Hex 1,26
Länge [mm]	25	31	25	31
REF	31.018.71.025	31.019.71.031	31.020.23.025	31.021.23.031
Preis [EUR]	30,-	30,-	15,-	15,-

Instrumente

Hex 1,22 - kompatibel zu FX



Anschluss	Hex 6,4	Hex 6,4	Dental DIN EN ISO 1797	Dental DIN EN ISO 1797
<i>Instrument</i>	Hex 1,22	Hex 1,22	Hex 1,22	Hex 1,22
<i>Länge [mm]</i>	25	31	25	31
<i>REF</i>	31.030.71.025	31.031.71.031	31.032.23.025	31.033.23.031
<i>Preis [EUR]</i>	30,-	30,-	15,-	15,-

Hex 1,01 - kompatibel zu DS-AY



Anschluss	Hex 6,4	Hex 6,4	Dental DIN EN ISO 1797	Dental DIN EN ISO 1797	Hex 6,4
<i>Instrument</i>	Hex 1,01	Hex 1,01	Hex 1,01	Hex 1,01	Löseinstrument
<i>Länge [mm]</i>	25	31	25	31	
<i>REF</i>	31.038.71.025	31.039.71.031	31.040.23.025	31.041.23.031	31.050.71.025
<i>Preis [EUR]</i>	30,-	30,-	15,-	15,-	30,-

Hex 1,40 - kompatibel zu ME-IX



Anschluss	Hex 6,4	Dental DIN EN ISO 1797
<i>Instrument</i>	Hex 1,40	Hex 1,40
<i>Länge [mm]</i>	25	25
<i>REF</i>	31.042.71.025	31.044.23.025
<i>Preis [EUR]</i>	30,-	15,-

UniGrip - kompatibel zu NB-AV / NB-RS



Anschluss	Hex 6,4	Hex 6,4	Dental DIN EN ISO 1797	Dental DIN EN ISO 1797
<i>Instrument</i>	UG	UG	UG	UG
<i>Länge [mm]</i>	25	31	25	31
<i>REF</i>	31.026.71.025	31.027.71.031	31.028.23.025	31.029.23.031
<i>Preis [EUR]</i>	30,-	30,-	15,-	15,-

Eindrehinstrument Multi-Unit (Multi-Unit Serie)



Anschluss	Hex 6,4
<i>REF</i>	31.030.00.188
<i>Preis [EUR]</i>	30,-

Installationsanleitung der Heliocos Bibliotheken

Unter <https://www.heliocos.de/medien> finden Sie die Anleitung zum Download und zur Installation der Heliocos Bibliotheken.

Hinweise für Exocad®

1. Wählen Sie die passende Heliocos Serie

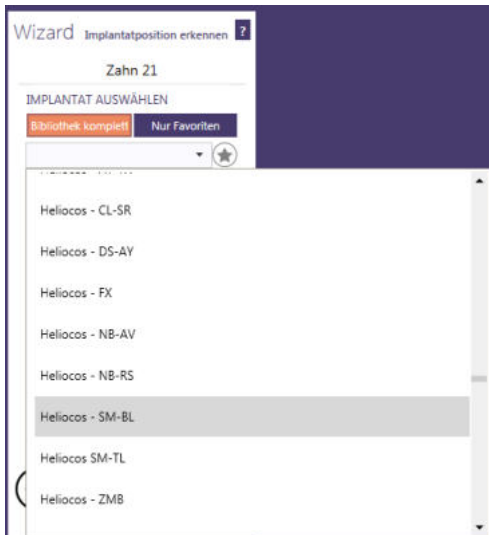

Heliocos Serie	Exocad Abkürzung	Kompatibel zu:
SM-BL	STR-BL	Straumann® - Bone Level
SM-TL	STR-TL	Straumann® - Tissue Level
CL-SR	CL-SL	Camlog® - Screw Line, Root-Line2®
CL-CO	CL-COL	Camlog® - Conelog®
FX	FX	Dentsply® - Xive® S
DS-AY	DS-ANK	Dentsply® - Ankylos®
AT-EV	DS-OSSEV	Dentsply® - Astra Tech® OsseoSpeed® TX
AT-TX	DS-OSSTX	Dentsply® - Astra Tech® EV
NB-AV	NB-AV	Nobel Biocare® - Conical Connection (Active)
ZMB	ZI	Zimmer Dental® / MIS® / Biohorizons® - Hex

2. Wählen Sie die gewünschte Plattform (Durchmesser)



3. Wählen Sie die gewünschte Versorgung

Ti Base B H4

→ Kaminhöhe, hier 4 mm

→ Ausrichtung der Abwinkelung

→ Titanbasis / Klebebasis

rot = rotatorisch / ohne Index

Pre-Mill = Fräsrohling für individuelles Abutment, Rohling-Ø = 11,5 mm

Hinweise für 3shape®

1. Wählen Sie in der Kategorie „Heliocos“

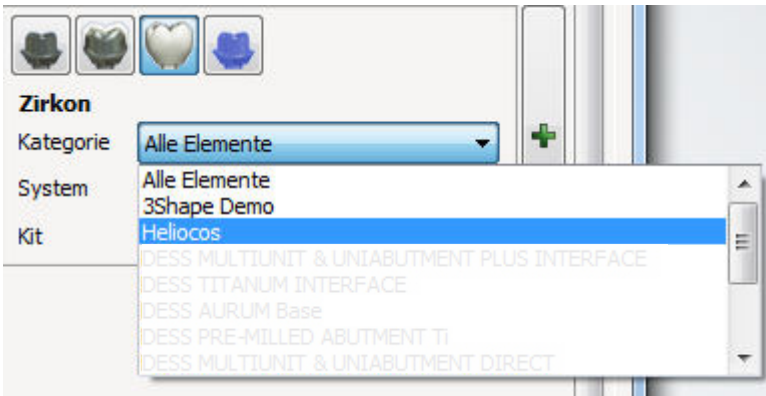

2. Wählen Sie die passende Heliocos Serie

Heliocos Serie	Kompatibel zu:
SM-BL	Straumann® - Bone Level
SM-TL	Straumann® - Tissue Level
CL-SR	Camlog® - Screw Line, Root-Line2®
CL-CO	Camlog® - Conelog®
FX	Dentsply® - Xive® S
DS-AY	Dentsply® - Ankylos®
AT-EV	Dentsply® - Astra Tech® OsseoSpeed® TX
AT-TX	Dentsply® - Astra Tech® EV
NB-AV	Nobel Biocare® - Conical Connection (Active)
ZMB	Zimmer Dental® / MIS® / Biohorizons® - Hex

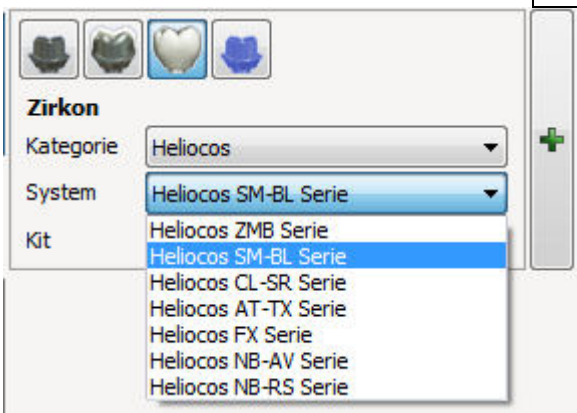

3. Wählen Sie die passende Plattform und die gewünschte Versorgung

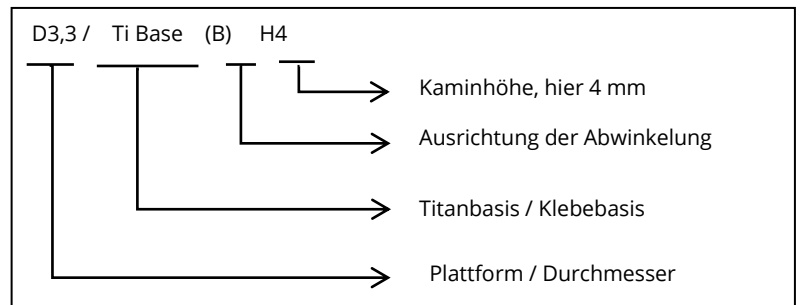
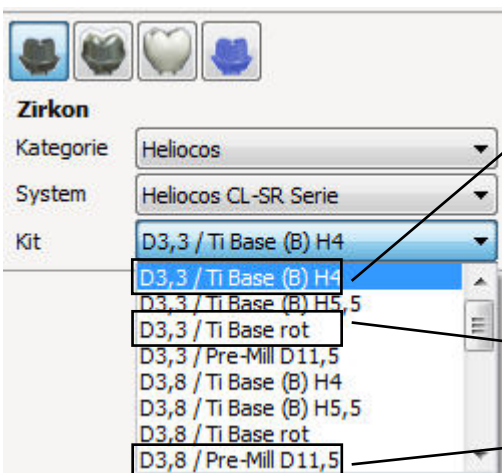

rot = rotatorisch / ohne Index

Pre-Mill = Fräsrohling für individuelles Abutment, Rohling-Ø = 11,5 mm

Etiketten

Etiketten

Vorderseite

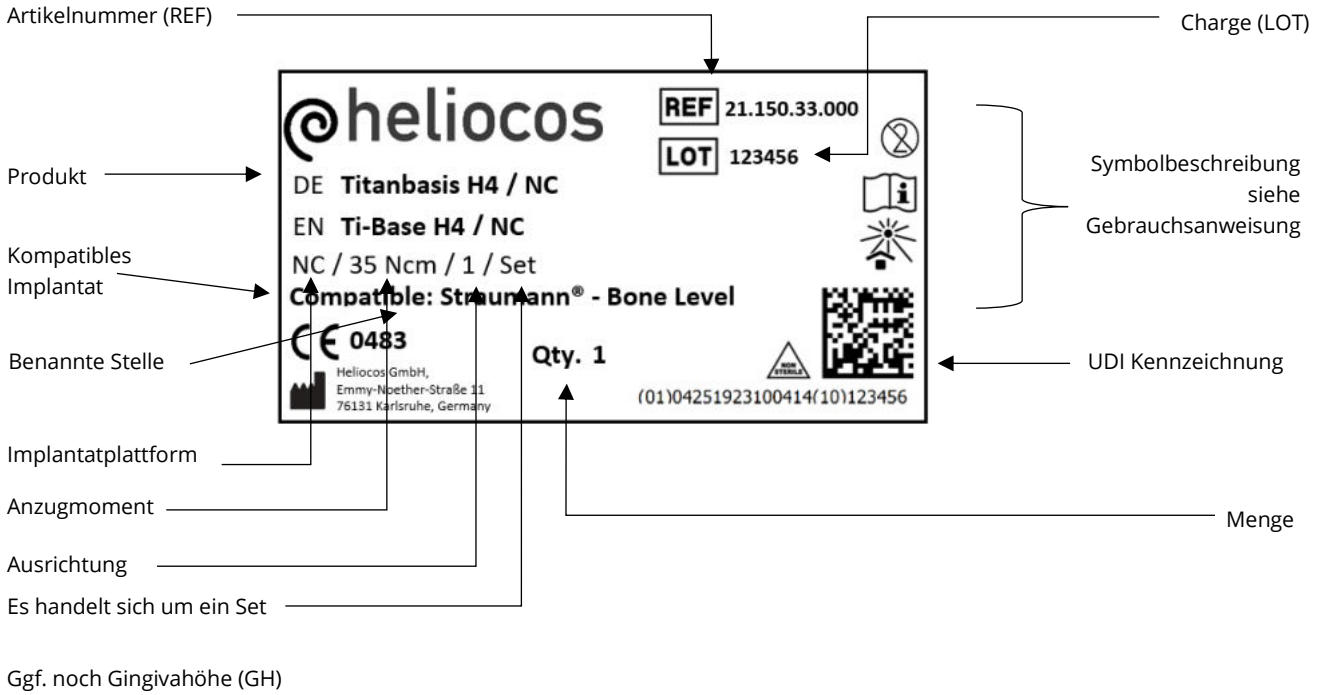

Rückseite

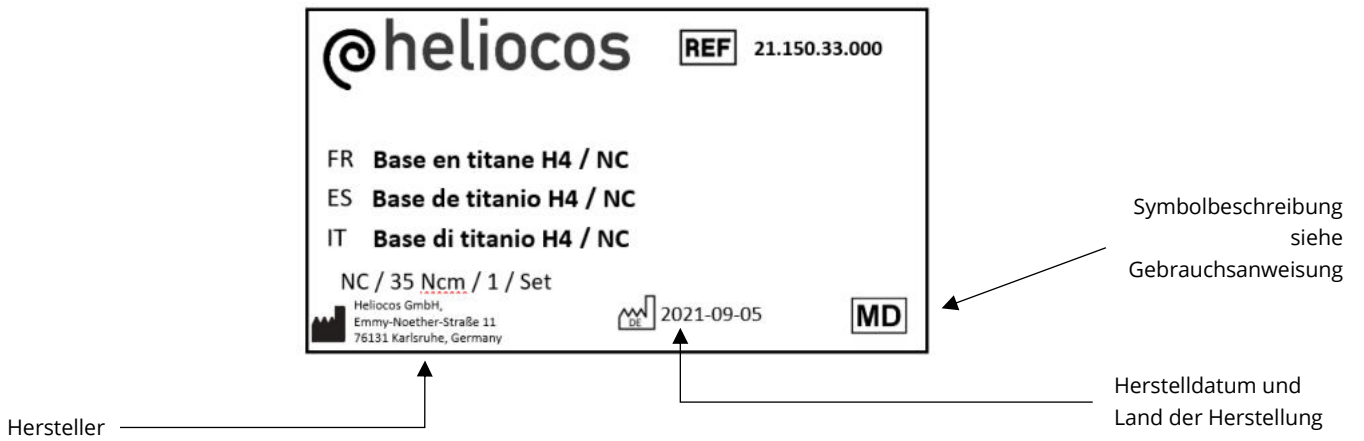

Patientenetikett

Patientenetikett für den Implantatpass (Zwei Etiketten pro Verpackung)

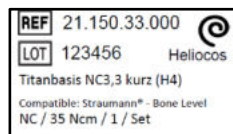

Wissenswertes zur rechtlichen Situation

Die rechtliche Situation bei kompatiblen Produkten



Das Risiko steigt für den Behandler nicht, wenn er Teile verschiedener Hersteller kombiniert, wenn diese Teile für die Kombination vorgesehen sind. Das bedeutet, wenn der Behandler unsere Abutments mit einem Originalimplantat kombiniert, welche dafür vorgesehen sind, gibt es kein rechtliches Risiko. Die Zuordnung steht in der Gebrauchsanweisung und auf dem Etikett.

Die Gewährleistung bzw. die Sachmängelhaftung



Jeder Hersteller haftet für Mängel seines Produktes. Das gilt auch, wenn dieses mit anderen Teilen kombiniert wird. Wir haften für unsere Produkte, so wie der Hersteller des Implantats für dieses haften muss.

Die Garantie



Die Garantie ist eine freiwillige Leistung. Weil wir von unseren Produkten überzeugt sind, geben wir 30 Jahre Garantie.

IMPRESSUM

Emmy-Noether-Str. 11 | 76131 Karlsruhe | Germany
Tel +49 (0)721 75 40 36 40 | Fax +49 (0)721 75 40 36 34
info(at)heliocos.de | www.heliocos.de

Managing Director | Geschäftsführer:
Dr. Andreas Schütt
Registered Office | Sitz der Gesellschaft: Karlsruhe
Registered | Eingetragen beim Amtsgericht Mannheim: HRB 724128
VAT No. | UST-IdNr.: DE269066796

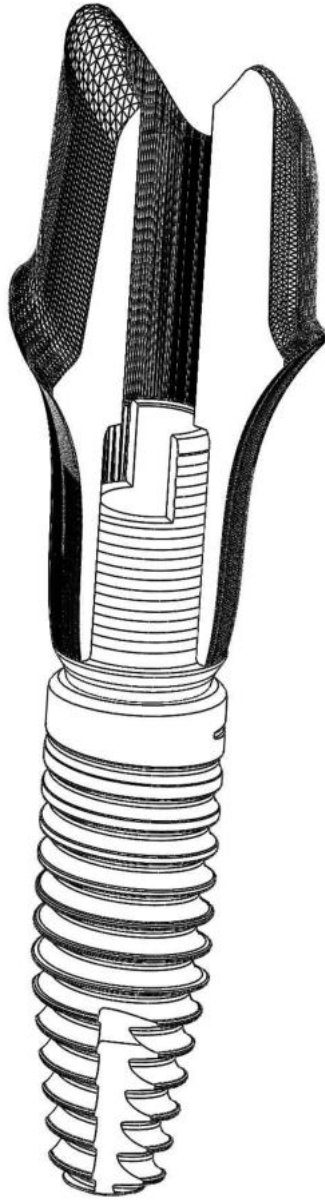

Emmy-Noether-Str. 11 | 76131 Karlsruhe
Tel +49 (0)721 75 40 36 40
Fax +49 (0)721 75 40 36 34
www.heliocos.de | info@heliocos.de